

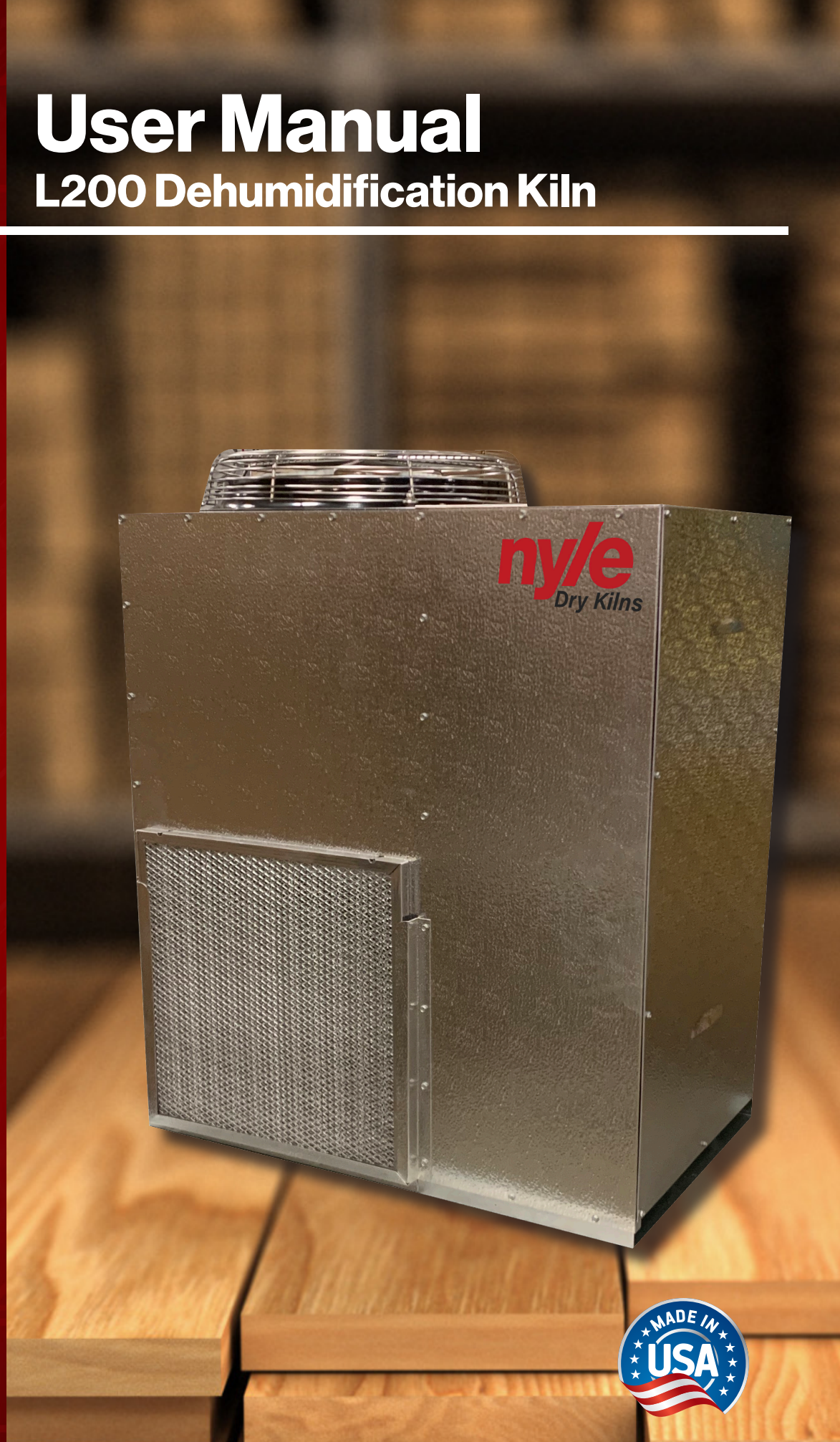

# User Manual

## L200 Dehumidification Kiln



© 2022 Nyle Dry Kilns  
L200 Manual Rev 2022.01



[www.nyle.com](http://www.nyle.com) - [kilnsales@nyle.com](mailto:kilnsales@nyle.com) - (800) 777-6953



# Table of Contents

---

<b>Safety Guidelines</b> .....	<b>1</b>
Precautions .....	1
Electrical Grounding .....	1
<b>Your Kiln</b> .....	<b>2</b>
How your Dehumidification Kiln Works .....	2
<b>Getting Started</b> .....	<b>2</b>
Floors .....	2
Ceilings .....	2
Doors .....	2
Construction Guidelines .....	3
Baffles and Deflectors .....	3
Power Vent .....	3
<b>Chamber Plans</b> .....	<b>4</b>
Chamber Dimensions .....	7
Wall Details .....	8
Front Elevation .....	9
Door Framing .....	10
Deflectors and Baffles .....	14
Equipment Front .....	15
Equipment Back .....	16
Power Vent Wiring .....	17
Fan Diagram .....	17
<b>Equipment Installation</b> .....	<b>18</b>
<b>Wet and Dry Bulb Sensors</b> .....	<b>18</b>
Sensor Technology .....	18
Dry Bulb Sensor .....	18
Wet Bulb Sensor .....	19
Wet Bulb & Dry Bulb Installation .....	19
<b>Kiln Control</b> .....	<b>19</b>
How the Controller Works .....	19
Using the L200S .....	19
Parameters .....	20
Settable Parameters .....	20
Alarm Conditions / Messages .....	20
L200S Technical Specifications .....	20
Control Wiring .....	21
Using the L200M .....	21
Parameters .....	21
Settable Parameters .....	21
Alarm Conditions / Messages .....	22
Timber Probes .....	22
Probe Placement .....	22
Table of Species in each Wood Group .....	23
L200M Technical Specifications .....	24
Control Wiring .....	24
<b>Drying Lumber</b> .....	<b>24</b>
Placing Stickers and Loading Lumber.....	24

Ensuring Proper Airflow .....	24
Drying Schedules .....	25
Wood Groups .....	25
Lumber Types .....	25
Moisture Removal Rates .....	26
L200 Drying Schedules .....	26
Drying Rates (North American Measure) .....	27
Drying Rates (Metric) .....	28
Kiln Sample Boards .....	29
Uses for Sample Boards .....	29
Taking Samples .....	29
Record Keeping.....	30
Drying Rate Index (DRI) .....	31
Drying Tips .....	32
<b>Nyle Drying Charts</b> .....	<b>33</b>
<b>Kiln Cart</b> .....	<b>35</b>
Kiln Cart Layout .....	35
Kiln Cart Assembly .....	35
<b>Wiring Diagrams</b> .....	<b>36</b>
<b>L200 Maintenance</b> .....	<b>38</b>
General Maintenance .....	38
Air Inlet Filters .....	38
Refrigerant Charging Procedure .....	38
Controller Factory Setting .....	38
<b>Appendix</b> .....	<b>39</b>
Terminology .....	39
<b>Troubleshooting</b> .....	<b>40</b>
<b>L200 Upgrades &amp; Accessories</b> .....	<b>41</b>
Spray Systems Kit .....	41
Heat Booster Package .....	41
<b>Kiln Store</b> .....	<b>42</b>
<b>Warranty</b> .....	<b>42</b>
<b>Wet Bulb &amp; Dry Bulb Installation Template</b> .....	<b>43</b>
<b>Service Log</b> .....	<b>45</b>
<b>Notes</b> .....	<b>46</b>
<b>Data Stickers</b> .....	<b>47</b>

# ⚠️ WARNING

**Read through entire manual before installing, operating, or servicing this unit.**

Failure to follow any steps or guidelines could result in personal injury, death, destruction of property or may cause the unit to become inoperable. These are the "original Instructions for this unit." **This manual must be kept with the unit at all times.**

## Safety Guidelines

### Precautions

Do not operate if the unit or any of its parts:

- Have been exposed to fire.
- Have been submerged in or exposed to excessive water.
- Has significant interior or exterior damage.

If any of the above are suspected make sure to have your unit serviced by a qualified professional before continuing operation.

*\*The unit is rated for an ambient temp of 10-40° C, 80 RH % at a maximum 200 meters.*

### Electrical Grounding

**The unit must be grounded.**

Failure to ground the unit will result in unreliable performance or an inoperative unit. You can ground the unit by connecting the unit to a grounded metal, permanent wiring system. Make sure the unit is in accordance with national and local electrical codes. If you don't know the building codes in your area or need more information, please contact your municipal office.

*\*Normally airborne noise is rated at 77 dB.*

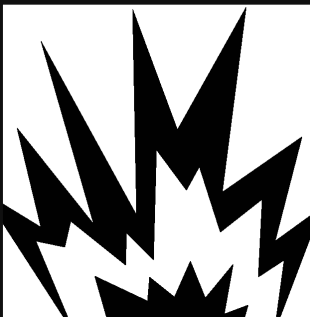
<h1>⚠️ WARNING</h1>	
<h2>Explosion Hazard!</h2>	
<ul style="list-style-type: none"> <li>• DO NOT purge or pressurize this system with oxygen to test for leakage. Using oxygen may cause explosive reaction.</li> </ul>	

# ⚠️ WARNING

## Refrigerant!

- Unit contains R-134a refrigerant under high pressure. Refrigerant must be recovered to relieve pressure before servicing.
- **DO NOT use unapproved refrigerants, substitutes or additives.**
- Failure to abide by these guidelines can result in death, injury and property damages.
- Contact Nyle's service department for more information on refrigerant options.

# ⚠️ WARNING

## High Temperatures!

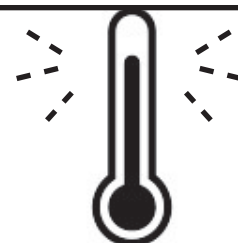

- Kiln chamber can reach internal temperatures of over 90°F. working in these temperatures can cause heat stroke and minor burns.
- Pregnant women, children, the elderly and those with significant health issues are at higher risk of heat stroke and must be supervised in high temperatures.
- Kiln operators should check for temperature and take proper safety precautions before entering the kiln chamber.

# ⚠️ WARNING

## Electrical Shock!

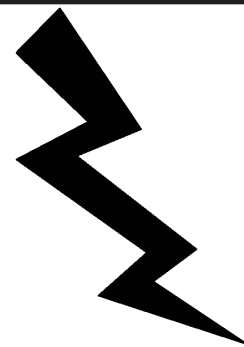

- **Turn off power to unit before service.**
- Make sure wires are labeled before disconnecting.
- Test unit after reconnecting wires.
- Failure to do the above could result in death or injury.

# ⚠️ WARNING

## Supervision!

- The appliance is not to be used by person (including children) with reduced physical, sensory or mental capabilities, or lack of experience and knowledge, unless they have been given supervision or instruction.
- Supervised children are not to play with the appliance.

## Your Kiln

### How your Dehumidification Kiln Works

Thank you for purchasing a Nyle Dehumidification Kiln and taking the first step towards making the lumber industry cleaner and more efficient! Years of development, innovation and the highest quality materials have gone into building your kiln. It's our dedication to efficiency that sets Nyle kilns apart from the rest making your system the best on the market.

During kiln drying, moisture from green lumber is evaporated into the air increasing the humidity inside the chamber. The lumber can't continue to dry if the air becomes over-saturated therefore the moisture must be periodically removed from the chamber. In a conventional kiln moisture would be expelled through venting. Venting causes a significant loss of heat resulting in a waste of energy to bring the kiln back up to temperature.

Instead of venting, Nyle Dehumidification Kilns utilize a refrigeration system that condenses the excess moisture. This moisture is then drained off retaining the existing heat energy. After the moisture is removed and heat is reintroduced to the dry air it is pumped back into the kiln chamber to start the process over. Unlike conventional kilns the heater in your Nyle Kiln is only used during the initial warm up and sometimes when temperature increases are desired during the cycle, saving you time and money. But that's not all your new kiln has to offer!

Though Nyle kilns don't rely on venting to get rid of moisture, a Vent System is supplied to add extra control of your kiln temperature. If the internal kiln temperature exceeds what's required, these vents can be opened to remove excess heat and bring the temperature back to where it needs to be.

Finally Nyle Systems offers a wide variety of upgrades and accessories to enhance your kiln drying experience. See the upgrades and accessories section on page 34 for more information. By purchasing a Nyle Kiln you have the support of Nyle's service team, the very same professionals that built and tested your unit. Enjoy your new system!

## Getting Started

*Please read through carefully as some options may not apply.*

### Floors

Concrete floors with insulation installed underneath is recommended for best results. However if the kiln is going to be on an existing concrete floor, the insulation may be omitted. Concrete must not extend beyond the kiln walls.

Wood floors may be used but must be built to construction guidelines (see Pg 3)

### Ceilings

If the kiln chamber is a freestanding outside building, the attic space must be well ventilated through the eaves. This is done to avoid any moisture buildup in this space, which will condense on the cold roof and drip onto the insulation.

An interior kiln can have the ceiling insulation open to the atmosphere.

Ceilings must be built to construction guidelines. (Pg 3)

### Doors

At the front of the kiln chamber install bay/loading doors with at least two sides hinges and a center door latch to close (recommended). Top hinged or a lift off doors are also acceptable.

At least one access door should be installed in the back of the chamber to allow for service of the dehumidifier and/or lumber monitoring.

All installed doors must:

- Be built to construction guidelines. However they may be lightened by increasing the stud spacing and using 3/8" plywood. The lighter weight will reduce the load on the hinges
- Have a vapor barrier.
- Have gaskets wherever the door meets the kiln; this will give a good, airtight fit.
- Have a scraper type weather strip to reduce air leakage if door sill is not present.

- Close tightly against the gasket using turnbuckles, tarp straps, lag studs with wing nut, etc.

**Remember:** There will be considerable expansion and contraction during kiln use so it is imperative to plan your kiln door construction accordingly.

While outside electronic moisture meters can be used to avoid entering the kiln, during the drying cycle, Nyle strongly recommends regular checks inside the kiln to visually inspect the surface or ends for checks, mold, stain as well as testing with a hand held meter.

## Construction Guidelines

*Please reference Chamber Plans for more information on construction.*

**Step 1:** Build all walls, ceilings and floors with a 2" x 4" framework using blue or pink Styrofoam (extruded polystyrene) friction fitted between the studs.

**Step 2:** Cover the interior face of the studs with a 1" layer of Celotex Thermax ( for better results overlap two ½" layers).

Celotex Thermax is foil faced polyisocyanurate (urethane) board which is orange or yellow in color and is available in 4' x 8' sheets of various thicknesses. Celotex Thermax is a trade name, similar products under other trade names are acceptable.

**Note:** If you want to use spray foam insulation, only use urethane based spray foam applied at 2.2lb/cu ft. Fiberglass is never recommended.

**Step 3:** Caulk joints and nail heads with a high temperature silicone (optional: apply aluminum tape over silicone)

**Step 4:** Cover Thermax with one or two layers of 6 mil polyethylene, then enclose with ½" CDX or marine grade plywood.

**Step 5:** Coat CDX interior surface with "mobile home or metal roofing aluminum paint"

**Note:** Paint is an asphalt based coating with powdered aluminum and fiber for strength, available in most hardware stores. Re-coat as necessary every year.

**Step 6:** Finish exterior walls to suit your tastes, but avoid galvanized steel or other ferrous sidings.

Once you have completed construction of the kiln chamber install the following air deflectors and baffles to control the airflow within the chamber.

## Baffles and Deflectors

Do not underestimate the effect of baffling. Correct baffling will result in faster and more even drying. The benefits more than offset the extra time and effort to correctly place the baffles.

- **Corner deflector:** typically made of plywood are used to help turn the airflow.
- **Top Baffle:** Hinged baffle that falls from the fan wall to the top of the load used to compensate for different load sizes, and allow for shrinkage of the board pile.
- **Side Baffle:** Baffle that closes in the open space when lumber that does not fill the entire width. This baffle can be fixed or portable.

Please reference pg 14 for more information on deflectors and baffles.

## Power Vent

The Power Vent is to be secured to the inside of the kiln wall with the fan side facing the exterior.



# Do It Yourself Chamber Plans

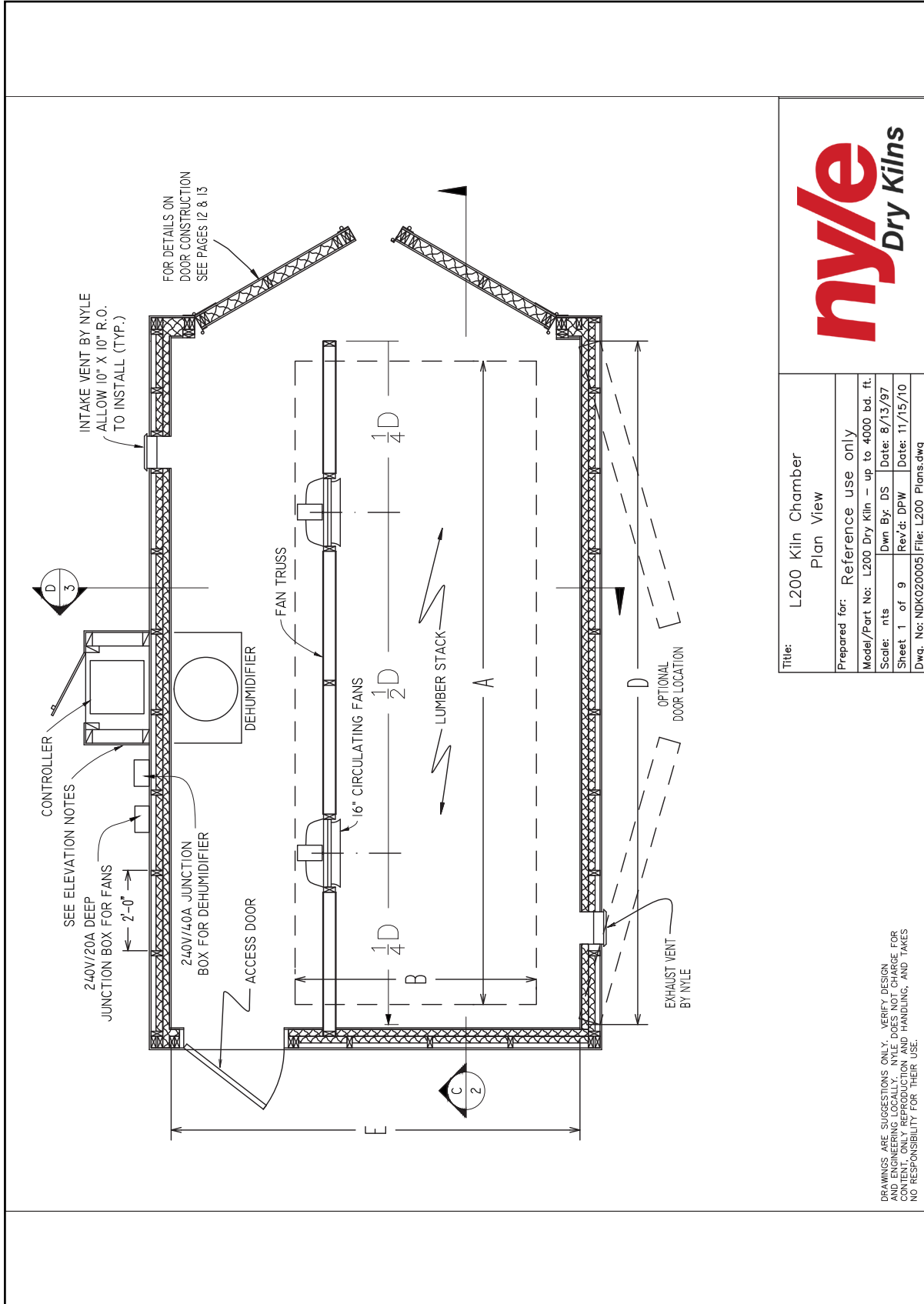

Title: L200 Kiln Chamber Plan View	
Prepared for: Reference use only	
Model/Part No: L200 Dry Kiln – up to 4000 bd. ft.	
Scale: nts	Dwn. By: DS Date: 8/13/97
Sheet 1 of 9	Rev'd: DPW Date: 11/15/10
Dwg. No: NDK020005   File: L200 Plans.dwg	

DRAWINGS ARE SUGGESTIONS ONLY. VERIFY DESIGN AND ENGINEERING LOCALLY. NYLE DOES NOT CHARGE FOR CONTENT, ONLY REPRODUCTION AND HANDLING, AND TAKES NO RESPONSIBILITY FOR THEIR USE.



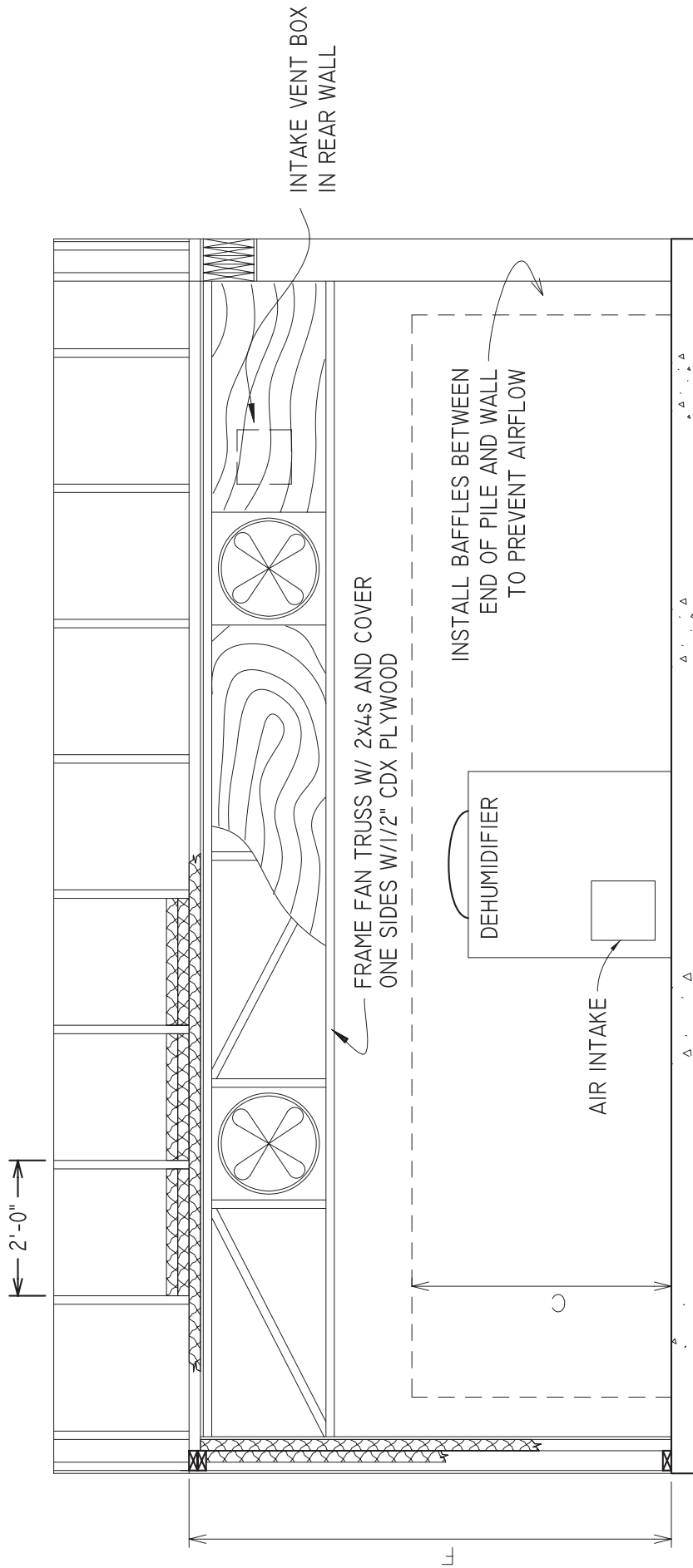

SECTION THROUGH KILN CHAMBER C  
6

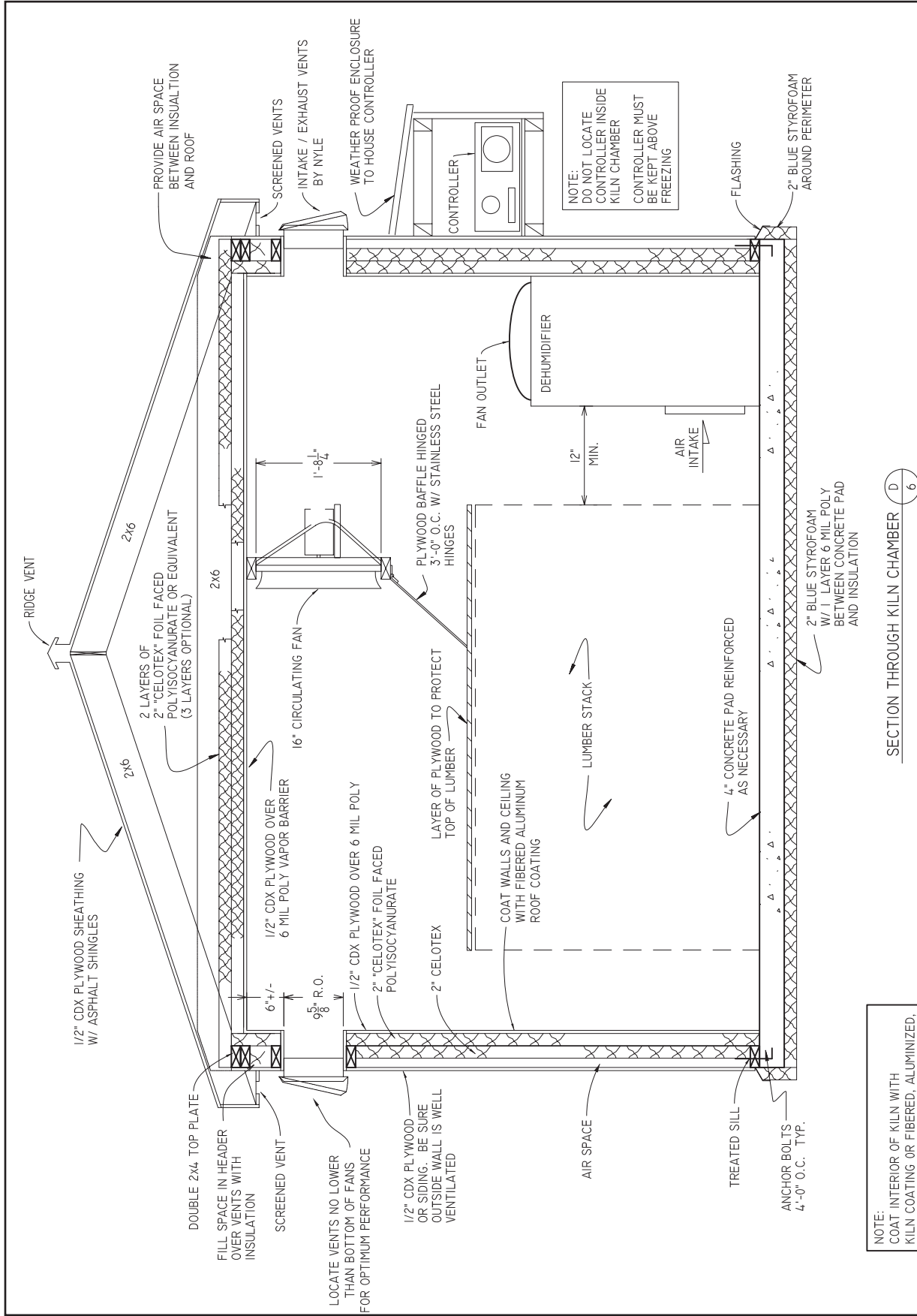

NOTE:  
DO NOT LOCATE  
CONTROLLER INSIDE  
KILN CHAMBER  
CONTROLLER MUST  
BE KEPT ABOVE  
FREEZING

NOTE:  
COAT INTERIOR OF KILN WITH  
KILN COATING OR FIBERED, ALUMINIZED,  
ASPHALT BASED METAL ROOF COATING  
TO PREVENT DETERIORATION

SECTION THROUGH KILN CHAMBER D  
6

# Chamber Dimensions

BOARD FT.	8' LUMBER						12' LUMBER						16' LUMBER									
	SIZE OF PACKAGE			SIZE OF BUILDING INSIDE			SIZE OF PACKAGE			SIZE OF BUILDING INSIDE			SIZE OF PACKAGE			SIZE OF BUILDING INSIDE						
	LENGTH (FT)	WIDTH (FT)	HEIGHT (INCH)	NO. OF COURSES	LENGTH (FT)	WIDTH (FT)	HEIGHT (FT)	LENGTH (FT)	WIDTH (FT)	HEIGHT (FT)	NO. OF COURSES	LENGTH (FT)	WIDTH (FT)	HEIGHT (FT)	LENGTH (FT)	WIDTH (FT)	HEIGHT (FT)	NO. OF COURSES	LENGTH (FT)	WIDTH (FT)	HEIGHT (FT)	
300	8	3	26	13	9	7	6															
500	8	3	42	21	9	7	6	12	3	28	14	13	7	6								
750	8	4	46	23	9	8	6	12	3	42	21	13	7	6								
1000	8	4	62	31	9	8	8	12	3	54	27	13	7	7	16	3	42	21	17	7	6	
1500								12	4	62	31	13	8	8	16	3	62	31	17	7	8	
2000								12	4	82	41	13	8	10	16	4	62	31	17	8	8	
2500								12	6	70	35	13	10	9	16	4	78	39	17	8	9	
3000								12	6	82	41	13	10	10	16	6	62	31	17	10	8	
3500															16	8	56	28	17	12	7	
4000															16	8	74	37	17	12	9	

WIDTH DIMENSIONS ARE MINIMUM ACCEPTABLE.  
 COURSES BASED ON NOMINAL 1" ROUGHSAWN LUMBER ON 3/4" STICKERS.

BUILDING DIMENSIONS ARE FOR OPEN SPACE INSIDE INSULATION.

ADDITIONAL INTERIOR CLEARANCE IS REQUIRED FOR USE OF A KILN CART.

# Wall Details

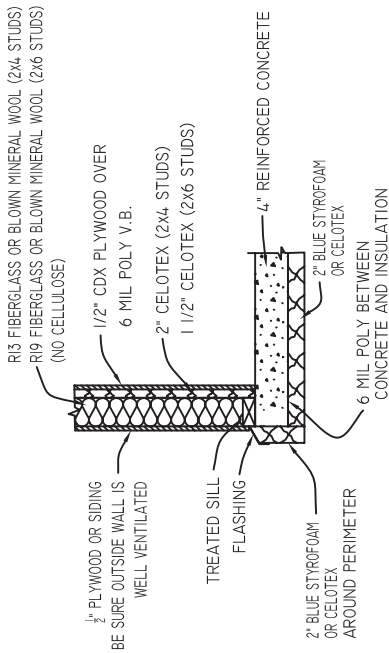

ALTERNATIVE WALL/CONCRETE FLOOR DETAIL

NOTE:  
ALTERNATIVE CONSTRUCTION METHODS MAY BE USED IN WALLS AND CEILING.

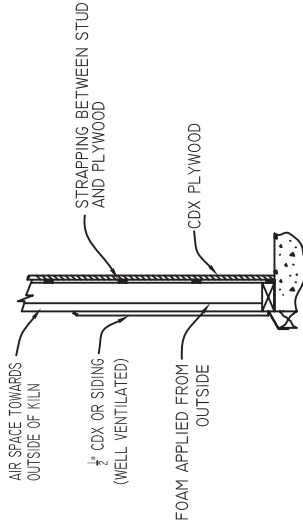

ALTERNATIVE STUD WALL SECTION  
SPRAYED URETHANE FOAM

URETHANE FOAM MUST BE APPLIED IN MULTIPLE APPLICATIONS AT A MAXIMUM DEPTH OF 1 1/2" PER COAT. A MINIMUM OF 4" OF FOAM IS REQUIRED AT A DENSITY OF 2 LBS PER CUBIC FOOT TO MEET THE R30 INSULATION REQUIREMENT.

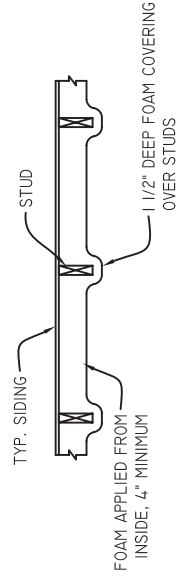

ALTERNATIVE STUD WALL SECTION

ALTERNATIVE SYSTEM:  
(2) 2" THK. LAYERS OF CELOTEX  
SAME SYSTEM MAY BE USED IN WALLS, ROOF, OR CEILING.

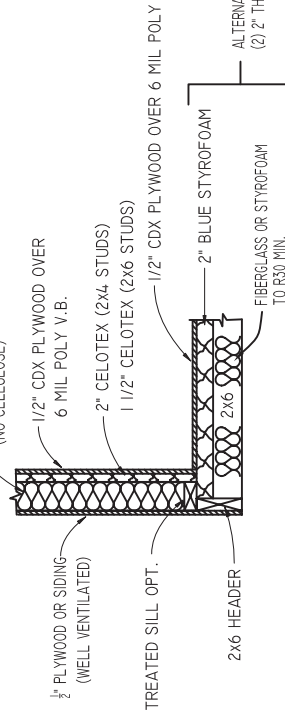

ALTERNATIVE WALL/WOOD FLOOR DETAIL

NOTE:

- 1) POLYISOCYANURATE INSULATION BOARD (CELOTEX, THERMAX, OR TUFF-R) IS STRONGLY RECOMMENDED FOR INTERIOR INSULATION SHEATHING. 1" IS SHOWN BUT THICKER IS PREFERRED ESPECIALLY IF USING FIBERGLASS OR BLOWN MINERAL WOOL INSULATION.
- 2) DO NOT USE CELLULOSE OR EXPANDED POLYSTYRENE (WHITE STYROFOAM) INSULATION IN THE DRYING KILN
- 3) ALL INTERIOR FASTENERS SHOULD BE STAINLESS STEEL.
- 4) INSTALL INTAKE/EXHAUST VENTS AT CONVENIENT ELEVATION TO ALLOW FOR MANUAL ADJUSTMENT.
- 5) POWERED VENT SYSTEM AVAILABLE. CONTACT NYLE. FIT SAME ROUGH OPENINGS.
- 6) COAT INTERIOR WALL AND CEILING SURFACES WITH FIBERED ALUMINUM ROOF COATING.

# Front Elevation

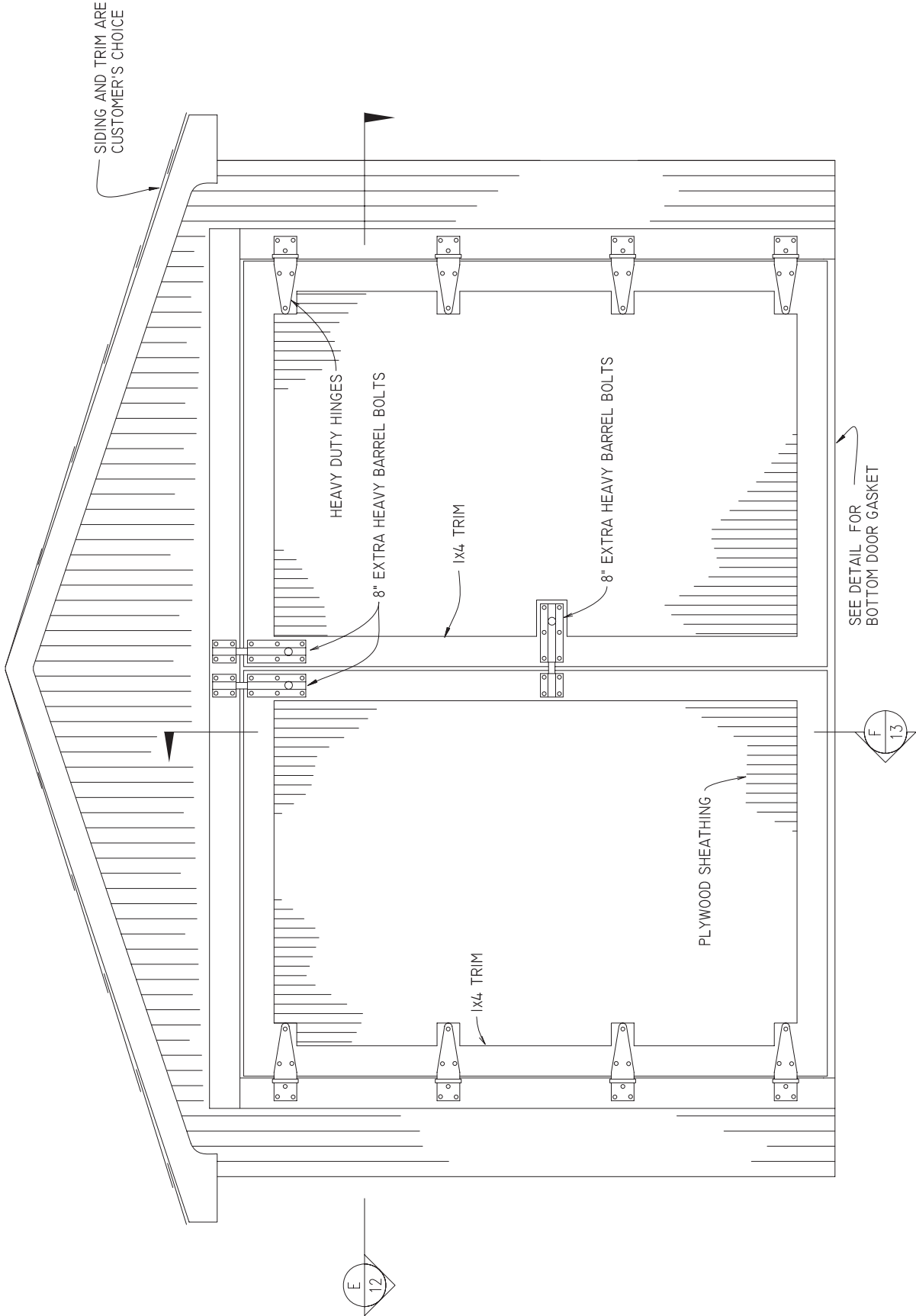

NOTE: DOOR GASKET KITS ARE AVAILABLE FROM NYLE AS AN OPTION.

# Door Framing

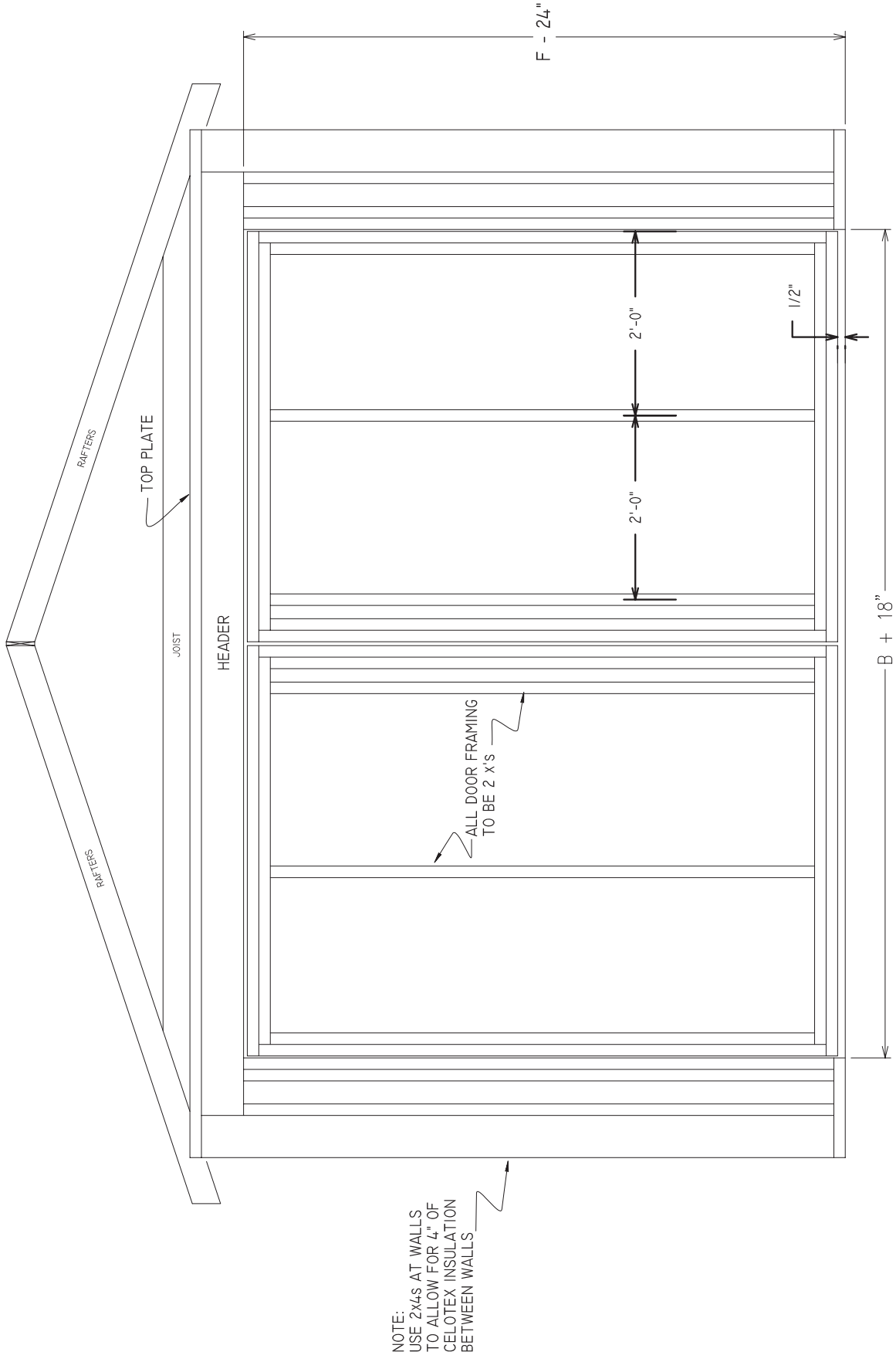

FRONT WALL AND DOOR FRAMING

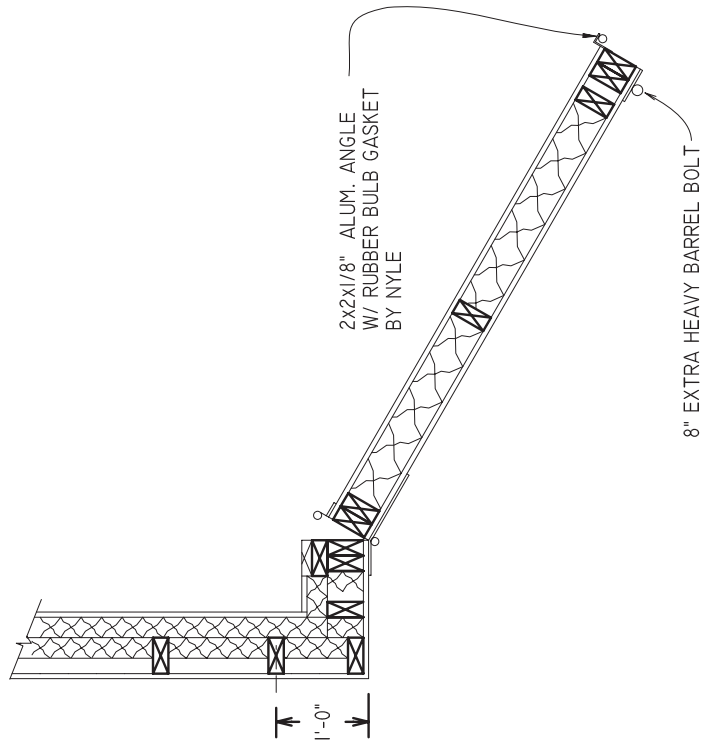
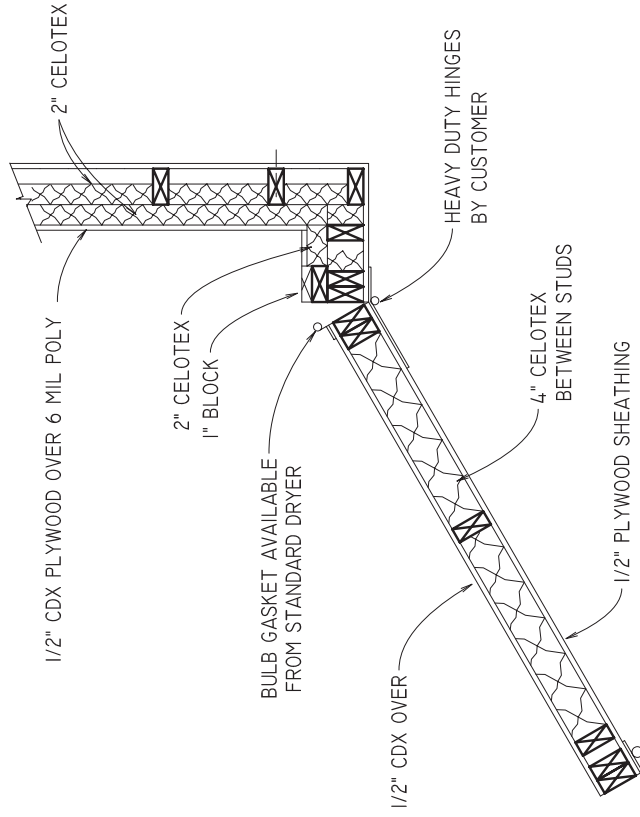

SECTION FRONT WALL OF KILN CHAMBER  
 W/ 2 SWINGING DOORS

NOTE:  
 COAT INTERIOR OF KILN WITH KILN COATING  
 (FIBERED, ALUMINIZED ASPHALT BASED METAL  
 ROOF COATING) TO PREVENT DETERIORATION.

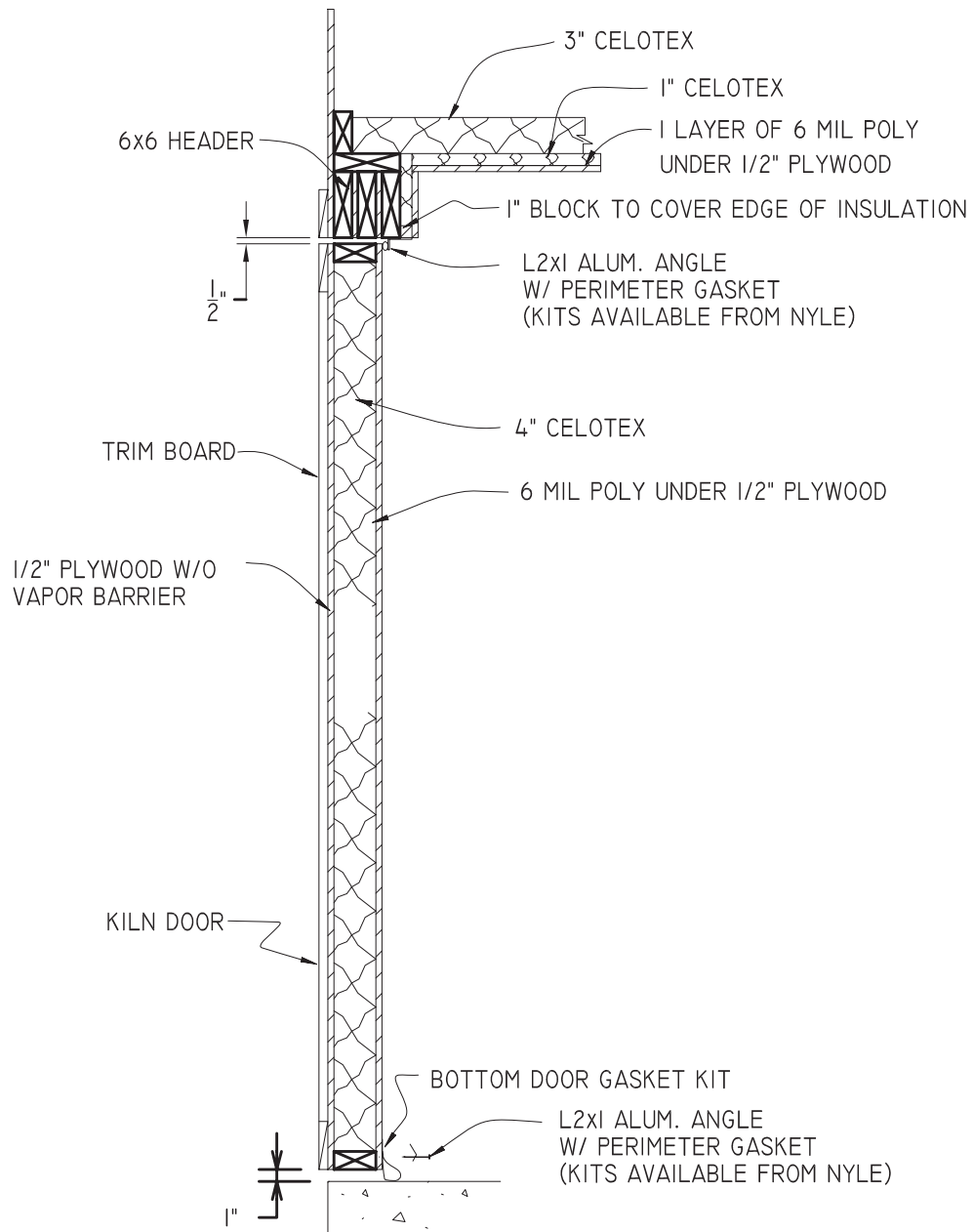

SECTION KILN DOOR AND HEADER F  
13



GASKETS AND DOOR KITS AVAILABLE FROM NYLE

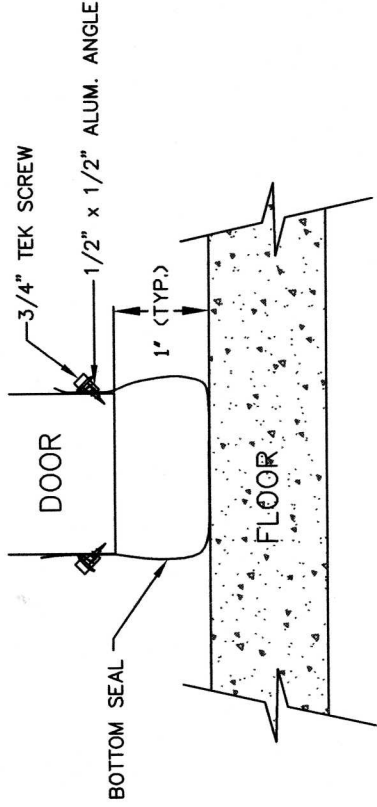

INSTALLATION OF BOTTOM DOOR GASKET

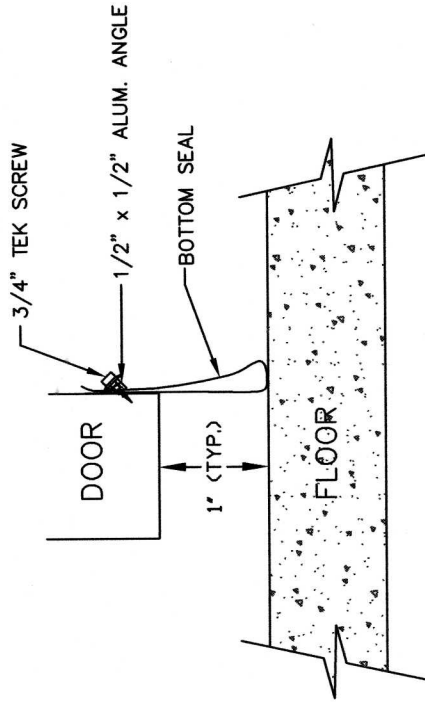

ALTERNATE INSTALLATION OF  
BOTTOM DOOR GASKET

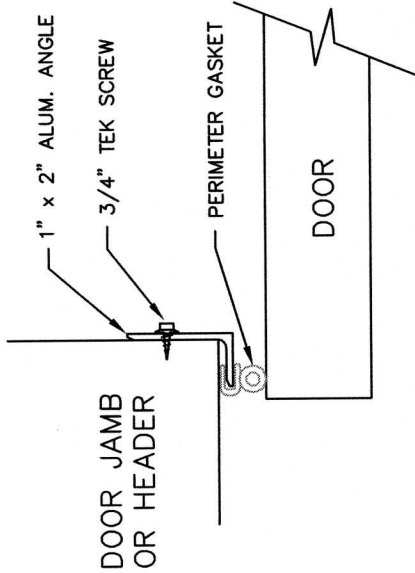

DOOR PERIMETER GASKET  
INSTALLATION

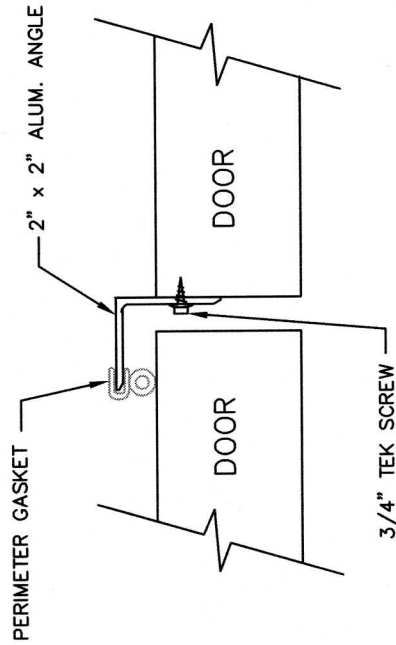

INSTALLATION OF CENTER DOOR GASKET

ADJUST ANGLE INSTALLATION SO THAT  
GASKET IS SLIGHTLY COMPRESSED

# Deflectors and Baffles

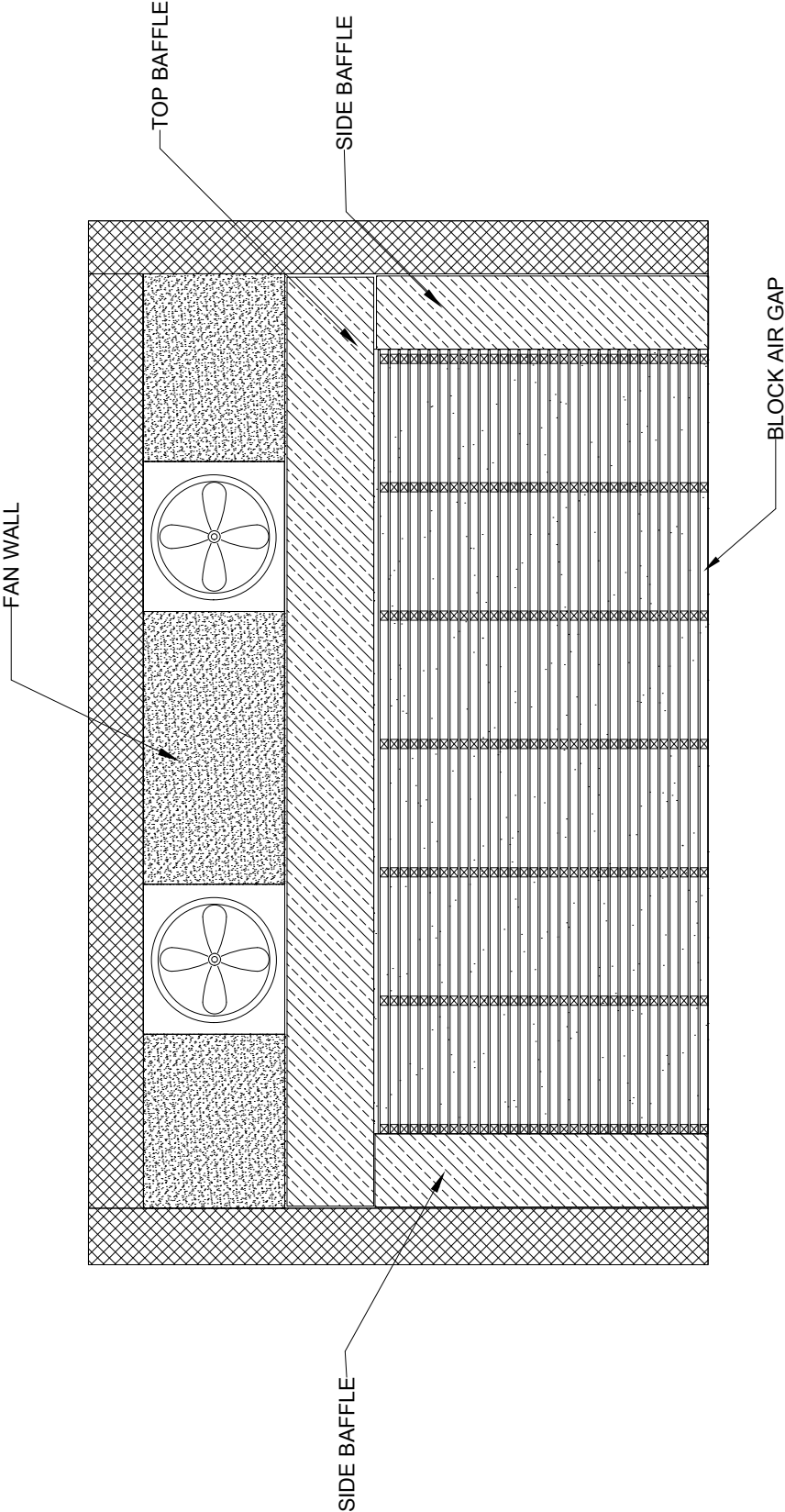

**STACKING & BAFFLING**  
CLOSE ALL LARGE AIR GAPS SO THAT AIR CAN ONLY PASS THROUGH THE STICKER SPACE  
CAREFULLY ALIGN STICKERS VERTICALLY  
HANGED BAFFLE FROM FANWALL TO FRONT EDGE OF LUMBER STACK

# Equipment Front

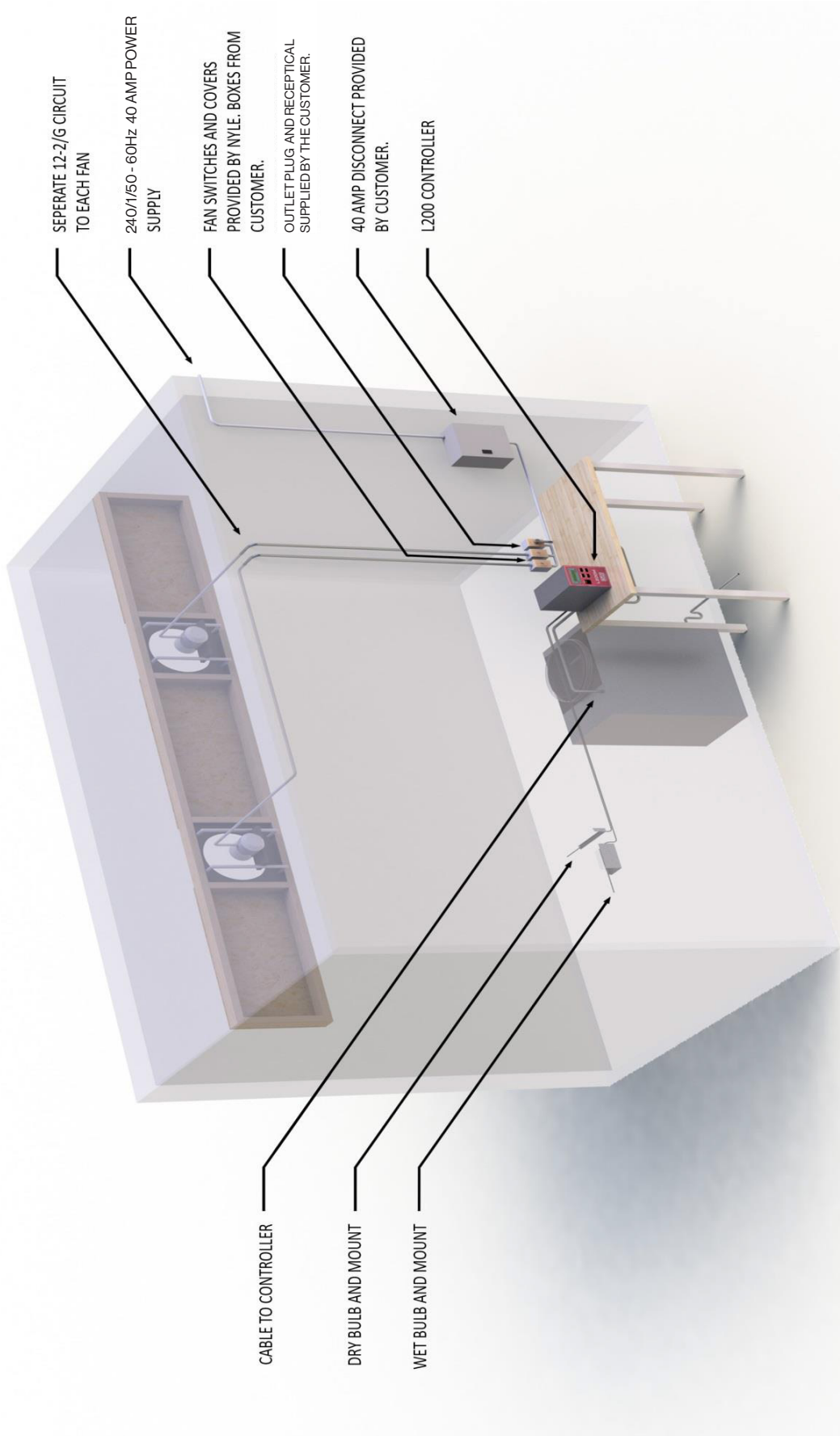

# Equipment Back

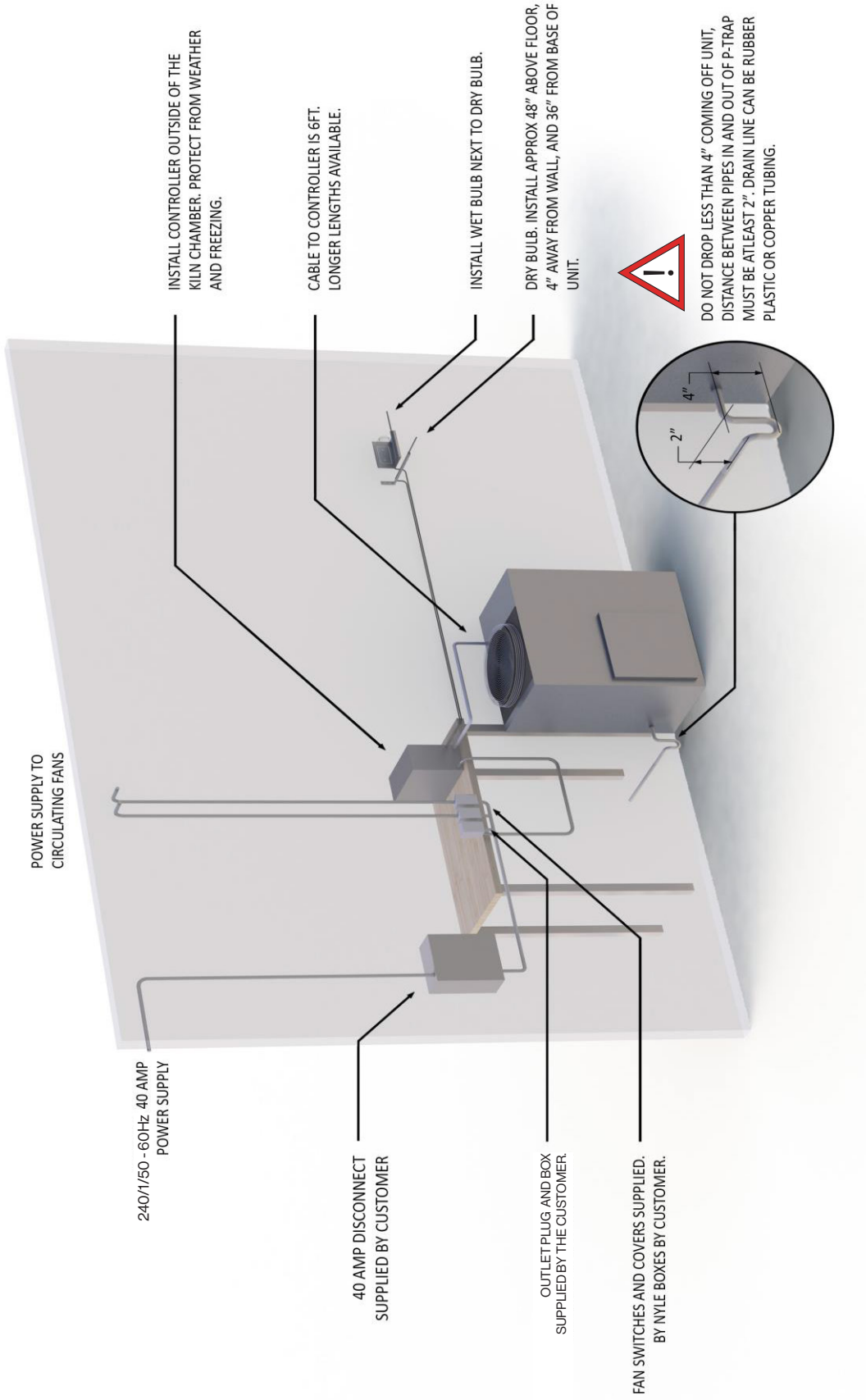

## Power Vent Wiring

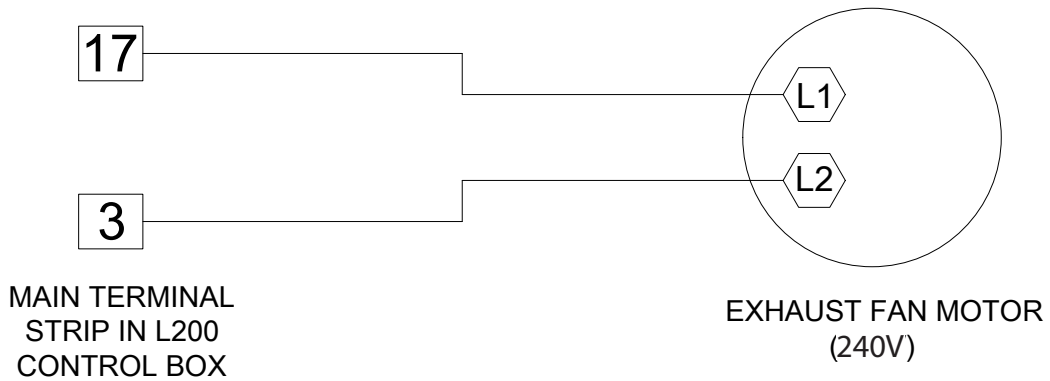

## Fan Diagram

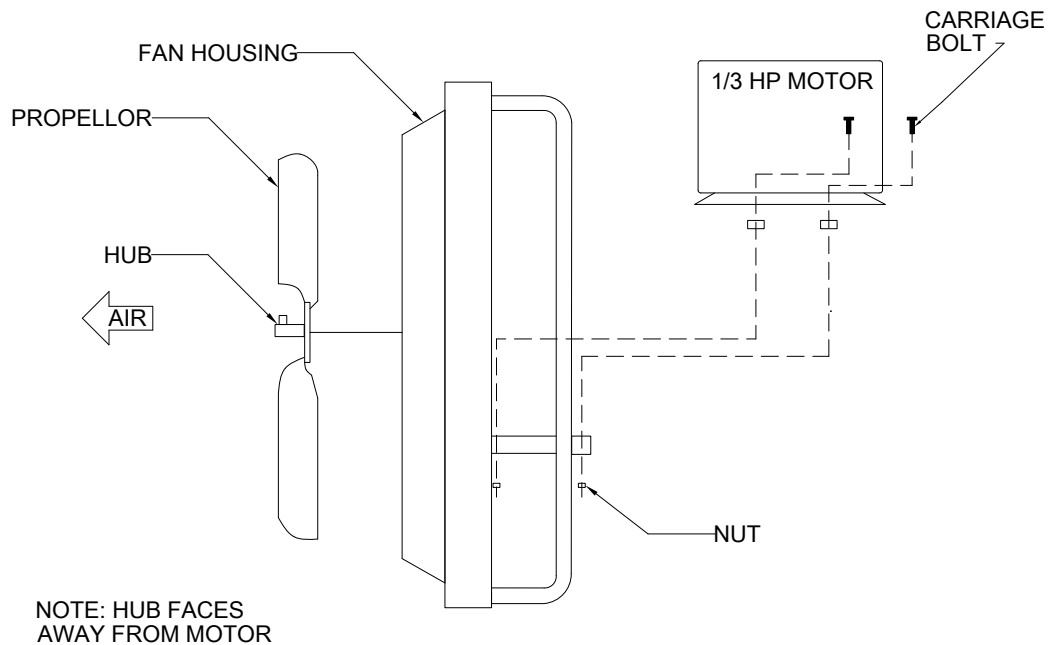

1. MOUNT MOTOR ON BASE USING BOLTS AND NUTS PROVIDED
2. PLACE FAN ON MOTOR SHAFT SO THAT ONE SCREW SET MEETS THE FLAT OF THE SHAFT. TIGHTEN BOTH SET SCREWS
3. ADJUST THE MOTOR SO THAT THE TIO OF THE BLADE IS EVENLY SPACED AND AT THE TRHOAT OF THE VENTURI
4. FAN MOTOR CAN BE WIRED FOR 240V OR 120V BUT THE SWITCH SUPPLIED IS 240 VOLTS ONLY. IT HAS A BUILT IN OVERLOAD.

WIRING SUGGESTION : CHECK ON LOCAL CODES

## Equipment Installation

---

*Please reference Chamber Plans for more information on installation.*

**Step 1:** Place the dehumidifier at the center of the long wall with the inlet filter facing the board pile.

**Step 2:** Connect an appropriate length drain hose. *The drain must have a trap.*

**Note:** The dehumidifier can be elevated to any reasonable amount to help the drain gravity feed. The wall opening should be sealed around where the drain hose extends outside of the chamber. **Never have a floor drain.**

**Step 3:** Place the controller at a convenient point outside the chamber near the dehumidifier.

**Note:** Be sure controller is in a space that will not reach temperatures below freezing.

**Step 4:** Remove the cover

**Step 5:** Drill 2 holes in the kiln wall to allow control cables and separately the sensor wires (inside the controller) to be carefully routed into the chamber. **Do not route control and sensor wires through the same hole.**

**Step 6:** Mount the Dry Bulb Temperature Sensor 6 to 12 inches from the wall 4 feet off the floor, at least 3 ft from kiln unit, away from the blower outlet, for an accurate reading. **See "Wet Bulb & Dry Bulb Installation" on the next page**

**Step 7:** Remove the right side panel of the dehumidifier gaining access to the compressor and terminal strip.

**Step 8:** Securely connect the control cable to the dehumidifier.

**Step 9:** Carefully connect each wire to their corresponding terminal. Do not stretch or over stress the cable.

**Note:** Wire insulation is marked with the corresponding terminal number.

**Step 10:** Seal the holes in the kiln wall after wires are installed to keep moisture from the control box.

**Step 11:** Install the fans over the lumber see Chamber Plans as a reference.

**Step 12:** Install and caulk the vents so that they are on opposite sides of the fans and at opposite ends of the kiln.

**Note:** The vents should be located as shown on the chamber drawings.

**Step 13:** With the system switch in OFF position, connect the control box to power.

The unit is now ready for the check out procedure.

## Wet and Dry Bulb Sensors

---

### Sensor Technology

Every Nyle Dehumidification Dry Kiln System measures and regulates internal kiln conditions through the use of Dry Bulb and Wet Bulb Sensor Technology. Each of these sensors measure different temperatures inside the kiln chamber and regulate various system functions. They provide information about the kilns internal conditions used to determine relative humidity (RH) and estimated moisture content (EMC). The two sensors are installed within the kiln chamber and are connected to the kilns controller. The information can be managed and utilized by the kiln operator, and stored for later reference.

### Dry Bulb Sensor

This sensor measures the dry bulb temperature (DBT). The DBT measurement given by the sensor is the true thermodynamic temperature inside the kiln. You can set the desired DBT from the kiln controller. This setting will control the kilns exhaust vents and heat, which will be automatically adjusted to accommodate the desired DBT.

**Example:** If the DBT falls below the set parameter the system will turn on the heat. Or if the DBT rises above the set parameter then the system will open the vents.

If your DBT is rapidly fluctuating a thermal lag may be added to the sensor to help stabilize readings, contact Nyle for information on how to install one if necessary.

## Wet Bulb Sensor

This sensor measures the wet bulb temperature (WBT). The sensor equipped with a water wick will be cooled through evaporation bringing its temperature reading below that of the dry bulb. This lower temperature is the WBT, it is the lowest temperature that can be reached inside of the kiln, through the evaporation of water, under the current ambient conditions. You can set the desired WBT from the kiln controller as well. This setting controls the kiln compressor and spray system which will be automatically adjusted to accommodate the desired WBT.

**Example:** If the WBT falls below the set parameter the system will turn on the spray system. Or if the WBT rises above the set parameter the system will turn on the compressor.

**Note:** Spray system is not included with your unit. See the upgrades and accessories section on page 41

## Wet Bulb & Dry Bulb Installation

Use Wet Bulb/ Dry Bulb template on page 43 to mark where all components go.

**Step 1:** Mount an 8" x 10" piece of wood on the kiln wall at a convenient height, roughly 4 feet (1.2m) off the floor and 3 feet (.92 m) from the unit so that it is receiving air flow from the circulating fans.

**Step 2:** install Wet Bulb & Dry Bulb brackets & sensors

**Step 3:** Install Wet Bulb bottle

**Step 4:** Put approximately 5 ft of the wick material in the bottle, looping it through the opening of the bottle.

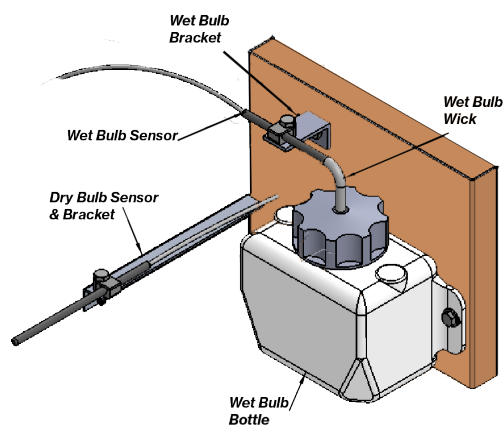

**Step 5:** Slide 2" (50mm) of the wick into the sensor.

**Step 6:** Fill the bottle with filtered water.

**Note:** Over time the wick material will become rough and unable to hold moisture. When this happens cut off and discard the damaged material and pull more wick out of the bottle.

**WARNING:** The wick surrounding the wet bulb must be maintained and always wet. The wet bulb must be positioned close to the dry bulb, in a position where it can still receive the airflow. If these conditions are not satisfied, the control could mis-regulate the kiln over drying and damaging the wood.

## Kiln Control

**Attention:** Before continuing please determine which controller you will be using.

### How the Controller Works

With the L200 Controller the user only needs to set the required temperature values for wet and dry bulb and L-SERIES will automatically manage the kiln heater, compressor, power vents (and optional spray system) in order to reach the requested settings for the kiln climate.

Use the difference between DBT and WBT to find the relative humidity (RH) and EMC of the air, using the tables on pg 32.

The L200M gives four different measuring points, using four timber probes that are connected to the lumber samples. (See page 22 for more information)

### Using the L200S

To turn the controller on turn the system switch to the on position.

The instrument model and software version will show briefly, then the display will look like Image on next page (values shown may be different).

If an error is displayed instead of the temperature values, please check the connection of the temperature probes.

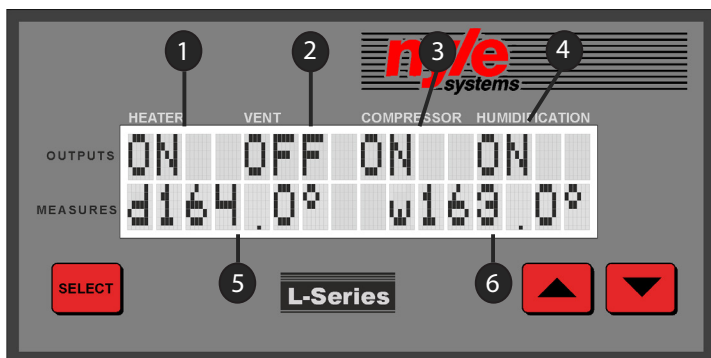

1	Heater Status	(ON/OFF)
2	Vent Status	(ON/OFF)
3	Compressor Status	(ON/OFF)
4	Humidifier Status	(ON/OFF)
5	Dry Bulb Temperature	
6	Wet Bulb Temperature	

## Parameters

The controller can be programmed with the required conditions to be maintained inside the kiln. These settings are saved in the controller's memory and preserved in the case of a loss of power.

To access the configuration mode, press "Select" key: the first parameter setting screen will appear.

Press the "Select" key again to cycle through each parameter option.

Use the up and down arrow keys to change the values of each parameter.

**Note:** The controller will automatically exit from the configuration mode after setting the last parameter or 10 seconds without any activity on the keyboard.

## Settable Parameters

See "Drying Schedules" on pg 20

1. **Dry Bulb Temperature** (20°C to 72°C/68°F to 160°F): is the desired temperature for the kiln. This set-point will manage the heater/vent relay accordingly.

**Screen Appearance:** 5 Dry bulb xx°

2. **Wet Bulb Temperature** (20°C/ 68°F to Dry bulb temperature): is the desired temperature for the required air moisture. This set-point will manage the compressor/ humidification relays

accordingly. **The maximum settable temperature is equal to the dry bulb temperature.**

**Screen Appearance:** 6 Wet bulb xx°

**Note:** The humidification (spray system) is an optional upgrade not included with this unit. See the upgrades and accessories section on page 34

## Alarm Conditions/Messages

The 200 controller can signal faults that may occur to the temperature probes. When a fault is detected, an error message is displayed instead of the temperature value of the faulted probe.

When this occurs the controller will not work properly and after about a minute all the output relays will turn off (safety condition) signaling a buzzer alarm.

### Error Messages:

**Low:** The temperature probe is either disconnected or the temperature is below 1°C. The most likely cause is a breakdown of the cable. Check carefully the cable and, if damaged, replace it with a new one.

**High:** The temperature probe has either malfunctioned or the temperature is higher than 119°C. The most likely cause is a short along the cable. Check carefully the cable and, if damaged, replace it with a new one.

**Err:** Signaled when the wet bulb temperature is equal to the dry bulb temperature. The most likely cause is a malfunction with the temperature probes / cables or the Wet bulb wick is dry. Check carefully the cable and Wet bulb wick.

## Technical Specs

Power supply	240Vac 50/60Hz ± 20% or 120Vac 50/60Hz ± 20%
Absorption	15W
Working Temperature	0/+40°C (32/104°F)
Temperature Measuring Range	0-99°C (32/210°F)
Temperature Measuring Resolution	0.1°
Temperature Probe	NTC Thermistor
Relay Outputs	4 (Heating, Spray, Vent, Compressor)
Relay Contact Ratings	250Vc -5A (Resistive Load)
Internal Fuse Ratings	5 x 20mm5A Fast
Instrument Size (LxHxW)	144 x 72 x 154mm



## Control Wiring

CN1	Pin		Function
	A	B	
	1	1	N/A
	2	2	N/A
	3	3	N/A
	4	4	N/A
	5	5	Wet Bulb Temp Probe
	6	6	Dry Bulb Temp Probe

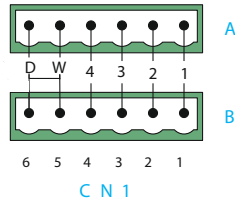

CN2	Pin	RS485 (Optional)
	1	Rx/Tx +
2	Rx/Tx -	
3	GND	



CN3	Pin	Function
	1	N/A
2	Compressor	
3	Vents Off	
4	Vents On	
5	Heater Off	
6	Heater On	
7	Spray System (Upgrade)	
8	Common	
9	N/A	
10	Phase	
11	Neutral (Supply)	

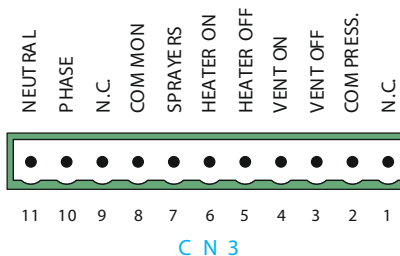

## Using the L200M

To turn the controller on turn the system switch to the on position.

The instrument model and software version will show briefly, then the display will look like Image on next page (values shown may be different).

If an error is displayed instead of the temperature values, please check the connection of the temperature probes.

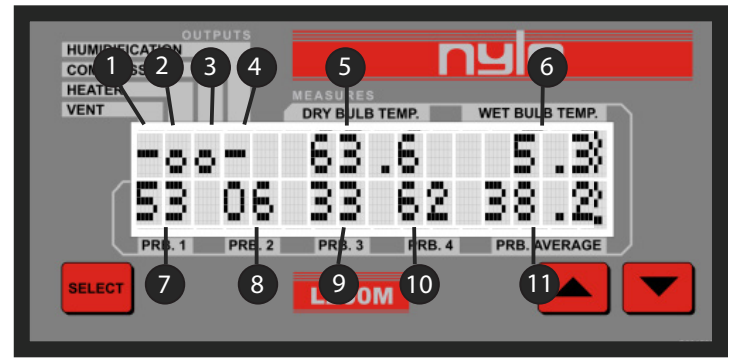

1	Heater Status	("o" ON/ "--" OFF)
2	Vent Status	("o" ON/ "--" OFF)
3	Compressor Status	("o" ON/ "--" OFF)
4	Humidifier Status	("o" ON/ "--" OFF)
5	Dry Bulb Temperature	
6	Wet Bulb Temperature	
7	Probe 1	
8	Probe 2	
9	Probe 3	
10	Probe 4	
11	Average Timber Moisture	

## Parameters

The controller can be programmed with the required conditions to be maintained inside the kiln. These settings are saved in the controller's memory and preserved in the case of a loss of power.

To access the configuration mode, press "Select" key: the first parameter setting screen will appear.

Press the "Select" key again to cycle through each parameter option.

Use the up and down arrow keys to change the values of each parameter.

**Note:** The controller will automatically exit from the configuration mode after setting the last parameter or 10 seconds without any activity on the keyboard.

## Settable Parameters

The L200M Continuously shows the values measured on the four timber probes (without decimals) and the average value (with decimals). You may remove one or more probes from the average calculation by pressing "Select" until the desired probe number is displayed, and then using the arrow keys to change the probes value. After doing this the probes value will display as "--" and will not be included in the average. You can not remove all of the probes from the calculation. If attempted the system will automatically display probe 1.

## See "Drying Schedules" on pg 20

1. **Dry Bulb Temperature** (20°C to 72°C/68°F to 160°F): is the desired temperature for the kiln. This set-point will manage the heater/vent relay accordingly.

**Screen Appearance:** 5 Dry bulb xx°

2. **Wet Bulb Temperature** (20°C/ 68°F to Dry bulb temperature): is the desired temperature for the required air moisture. This set-point will manage the compressor/ humidification relays accordingly. **The maximum settable temperature is equal to the dry bulb temperature.**

**Screen Appearance:** 6 Wet bulb xx°

3. **Final Moisture** (0% - 30%): is the desired moisture percentage at the end of a cycle. The kiln will automatically stop once this set point is reached. **This function can be disabled by setting this parameter to 0.**

**Screen Appearance:** 7 Final Moist xx

4. **Wood Group** (1 - 4 see table on page 23): This determined the correction factor that is applied to the moisture measure. This parameter must be set according to the timber species being dried. **The table contains only most commonly used species for ease of reference.**

**Screen Appearance:** Configuration 8 Wood group x

## Alarm Conditions/Messages

The 200 controller can signal faults that may occur to the temperature probes. When a fault is detected, an error message is displayed instead of the temperature value of the faulted probe.

When this occurs the controller will not work properly and after about a minute all the output relays will turn off (safety condition) signaling a buzzer alarm.

### Error Messages:

**Low:** The temperature probe is either disconnected or the temperature is below 1°C. The most likely cause is a breakdown of the cable. Check carefully the cable and, if damaged, replace it with a new one.

**High:** The temperature probe has either malfunctioned or the temperature is higher than 119°C. The most

likely cause is a short along the cable. Check carefully the cable and, if damaged, replace it with a new one.

**Err:** Signaled when the wet bulb temperature is equal to the dry bulb temperature. The most likely cause is a malfunction with the temperature probes / cables or the Wet bulb wick is dry. Check carefully the cable and Wet bulb wick.

**End of Cycle Press any Key:** Signaled when the desired moisture content has been reached. All outputs are turned off and waiting for a new cycle. Press any key to start a new cycle and/or change parameters.

## Timber Probes

L200M controller measures the woods moisture content by referring to its electrical resistance. Therefore, it is necessary to deeply fix timber probes into sample boards. The probes are connected by cables to the panel jacks on the controller, allowing them to provide accurate information directly to the system.

It is important to make sure that the sample boards you select represent the average moisture content of the load being dried. To establish which boards should be used you will need to test several boards in the load with a portable moisture meter, and average the moisture contents. Only select boards that are closest to this average.

## Probe Placement

Select probes that correspond to the thickness of the timber. They need to be embed roughly 1/2 - 1/3 the way through the board. Wrong sized probes will result in inaccurate information.

Probes need to be in the middle of the board, at least 15"-20" (40-50 cm) from the ends and set roughly 1¼" (30 mm) apart from each other, across the grain. **Do not place Probes along the grain. This system can only accurately measure moisture across the grain.**

Once probes are set the sample boards should be placed at different points inside the kiln dryer.

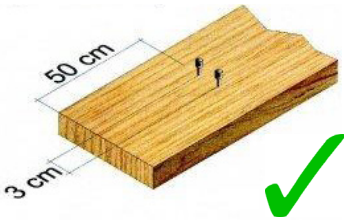

## Table of Wood Species in each Wood Group

Group 1		
Afromosia	Nyatoh	Zingana

Group 2					
American Ash	Assegai	Avodirè	Bahia	Beech	Blach
Bosso	Brasilian Palisander	Cedar	Cucuswood	Coigue	Dabema
Dogwood	Douglas	Ebony	Framirè	Freijo	Goncalo
Goupio	Green Heart	Guayacan	Indian Palisander	Ipe	Iroko
Issoua	Jarrah	Karri	Kempas	Macarati	Mahogany
Sapelli	Massaranduba	Mecrusse	Moabi	Mogano Khaya	Muhimbi
Muhuhu	Mukulungu	Mukusi	Niagon	Niove	Okouma
Olive Tree	Ostindisches	Panga Panga	Paranà Pine	Pau Rose	Pear Tree
Persimmon	Pillarwood	Poplar	Pyinkado	Quebracho Blanco	Quebracho Colorado
Ramin	Red Cedar	Rose Tree	Rosenholz	Samba	Sandelholz
Satinholz	Schlagenholz	Splined Ebony	Sucupira	Tali	Teak
Wacapou	Wattle	Wengè	Westindisches	Zapatero	

Group 3					
Abura	African Camphor	African Cedar	Afzelia	Agathis	Agba
Alder	Alstonia	Amarant	Amazakoue	Amen-doim	American Ash
American Cedar	American Maple	American Oak	American Pine	American Walnut	Andiroba
Andoung	Angelin	Angelique	Antiaris	Ash	Aspen
Assacu	Australian Blackwood	Austrian Pine	Azobè	Baboen	Baitoa
Balsa	Balsamo	Banga Wanga	Basswood	Berlinia	Bi-linga
Birch Tree	Blue Gum	Bombax	Bosse	Brushbox	Campeche
Cativo	Ceiba	Cherry Tree	Chestnut	Chestnut Oak	Chickrassy
Cocobolo	Courbaril	Cypress	Daniellia	Diambi	Douka
Echtes	Eibe	Elm	Essia	European Larch	Evino
Eyong	Guatambu	Haldu	Hemlock	Hickory	Hornbeam
Horse-Chestnut	Ilomba	Izombe	Jacareuba	Japanese Ash	Japanese Larch
Japanese Oak	Jelutong	Kapur	Kauri	Kiefer	Kotibe
Koto	Landa	Laurel Chile	Laurel Indian	Limba	Limbali
Linden Tree	Madrono	Magnolia	Mahagoni	Mahogany Kosipo	Mahogany Tiana
Makore	Manbarklak	Maninga	Manio	Maple	Meranti Bianco
Meranti Yellow	Merawan	Merbau	Mersawa	Movingui	Musizi
Mutenye	Myrtle	Naga	Oak	Okan	Olivillo
Ozigo	Padouk Africa	Padouk Burma	Padouk Manila	Paldao	Pardillo
Pernanbucco	Peroba	Peroba Rose	Pine Insigne	Pine Pitch	Pino Rosso
Pitch Pine	Plane Tree	Podo	Port Orford Cedar	Quaruba	Rauli
Red Cedar Virginia	Red Laurel	Red Pine	Red Spruce	Rengas	Robinia
Roble	Safukala	Saligna Gum	Sapo	Schirmbaum	Scotch Pine
Sen	Sequoia	Siberian Larch	Sikon	Slavonia Oak	Soft Maple
Spruce	Spruce Western With	Sugi	Sweetgum	Swiss Pine	Tchitola
Thuya-maser	Tulipier	Tupelo	Wacholder	Walnut	Weymouth
White Spruce	Willow	Yang	Yellow Birch	Yemane	

Group 4					
Alerce	Aningre	Bubinga	Dibetou	Imbuia	Mahogany Sipo
Mansonia	Meranti Dark Red	Meranti Light Red			

## Technical Specifications

Power supply	240Vac 50/60Hz ± 20% or 120Vac 50/60Hz ± 20%
Absorption	15W
Working Temperature	0/+40°C (32/104°F)
Temperature Measuring Range	0-99°C (32/210°F)
Temperature Measuring Resolution	0.1°
Temperature Probe	NTC Thermistor
Timber Moisture Measuring Range	8% - 90% at 25°C
Number of Probes	4
Relay Outputs	4 (Heating, Spray, Vent, Compressor)
Relay Contact Ratings	250Vc -5A (Resistive Load)
Internal Fuse Ratings	5 x 20mm5A Fast
Instrument Size (LxHxW)	144 x 72 x 154mm



**For L200M Only: If your control box is more than 50 ft from a ground rod, your moisture probes will not read correctly. A ground rod should then be installed at the disconnect or electrical panel near the control.**

### Control Wiring

CN1	Pin		Function
	A	B	
	1	1	Probe 1
	2	2	Probe 2
	3	3	Probe 3
	4	4	Probe 4
	5	5	Wet Bulb Temp Probe
	6	5	Dry Bulb Temp Probe
		6	Earth

CN2	Pin	RS485 (Optional)
	1	Rx/Tx +
	2	Rx/Tx -
3	GND	

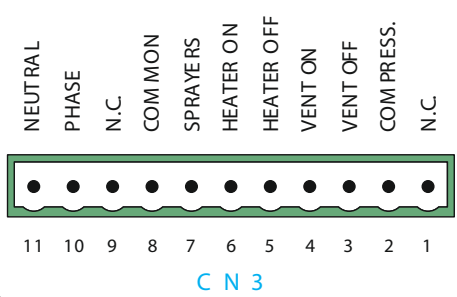
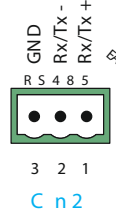
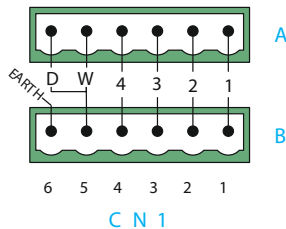

CN3	Pin	Function
	1	N/A
	2	Compressor
	3	Vents Off
	4	Vents On
	5	Heater Off
	6	Heater On
	7	Spray System (Upgrade)
	8	Relay Common
	9	N/A
	10	Phase
11	Neutral (Supply)	

## Drying Lumber

Nyle recommends that these guidelines be followed carefully.

### Placing Stickers and Loading Lumber

- Stickers should all be at least ¾" thick and all sticks in any load must be the same thickness.
- Thick lumber (10/4" and thicker) should be dried using double stickers.
- End stickers should be as close to the ends of the boards as possible.
- The sticker spacing should be approximately 18". This spacing can be reduced to 12" if excessive warping, cupping, and bowing are a problem.
- Keep stickers in a vertical line and always support the load under each sticker.
- If you have some wide boards, or other pieces that you want to keep as straight as possible, pile them on the bottom as the weight of the lumber above will constrain the wide boards and give the best result.
- If a less than full load is anticipated, it is better to reduce the depth rather than the height or width. This will obviously leave the stickers "hanging out", but will result in better drying.

### Ensuring Proper Airflow

- When the lumber is fully loaded, the baffles should be lowered to the top of the lumber and the side baffles should be carefully positioned.

If no side baffles are installed, the space could be closed off with plywood or boards.

- Never use plastic sheeting as it may come loose and become entangled in the fans.
- If the load supports are thicker than normal stickers, the extra space should be blocked with a narrow board or lath.
- Close off any large openings that will let air go around the lumber. Air will take the path of least resistance, and you must force it through the stickered pile.
- A small amount of time spent doing this correctly will result in more even, faster, and less expensive drying.

## Drying Schedules

Each species of lumber has a maximum rate of drying (expressed as % loss/day) that can be tolerated without damage. These rates have been determined through experimentation by the U.S. Dept. of Agriculture, various universities and others. Schedules have been developed based on time, dry bulb-wet bulb temperatures, and even automatic moisture content devices. Due to the many important variables that affect drying such as kiln chamber heat loss, air velocity, ambient temperature and humidities, vapor leaks, etc., the most important consideration of a schedule is that you maintain a safe drying rate.

The L200 drying system dries lumber by using the dry bulb and wet bulb temperatures of the kiln to control the operation of the dehumidifier. The schedules on page 20 are based on dry bulb and wet bulb conditions (humidity). These schedules are starting points; you will probably change these over time because you will find different settings work for you. This is due to the fact that different people saw boards differently, stack lumber differently, build chambers differently, etc.

If the dry bulb temperature is above 80°F, and the wet bulb is 2°F above its set point, (factory setting) the compressor will turn on. When the compressor is on, moisture is being condensed on the cold coil in the unit, and draining away. This moisture being removed reduces the humidity, dropping the wet bulb temperature.

The moisture removal rates on page 20 are the rates to follow when first using the machine. These rates can be safely exceeded by an additional 50% (i.e., 1.0% can be raised to 1.5% and 3.3% can be increased to almost 5%) given careful judgment and operating experience for Groups 1, 2, and 3. Top quality moisture meters, or weight samples, must be used at these higher drying levels to avoid lumber damage. Some hardwoods such as Southern Red Oak, White Oak, and Group 4 hardwoods should not use any sort of accelerated schedule.

## Wood Groups

<b>Group 1 (L200 load size, 1500 BF, 3.5m<sup>3</sup>)</b>
4/4 Softwoods
4/4 Soft Hardwoods
<b>Group 2 (L200 load size, 3000 BF, 7m<sup>3</sup>)</b>
4/4 Medium Hardwoods
8/4 Softwoods
8/4 Soft Hardwoods
<b>Group 3 (L200 load size, 4000 BF, 9m<sup>3</sup>)</b>
4/4 Hardwoods
8/4 Medium Hardwoods
<b>Group 4</b>
8/4 Hardwoods

**Note:** When drying a mixed load of woods, colored wood (ie Red Oak) must be stacked on the bottom to prevent the moisture from it staining the other wood.

## Lumber Types

<b>Softwood</b>			
Cedar, Eastern White	Pine, Red (Norway)	Spruce, White	
Fir, Balsam	Pine, Eastern White		
Hemlock, Eastern	Spruce, Black		
Larch, Eastern	Spruce, Red		
<b>Soft Hardwoods</b>			
Aspen			
Basswood			
Cottonwood			
Poplar			
<b>Medium Hardwood</b>			
Ash, Black	Birch, Yellow	Maple, Soft	Walnut
Ash, White	Cherry, Black	Maple, Hard	
Beech	Elm, White	Sweet gum (Red gum)	
Birch, White	Hickory	Tupelo (Black gum)	
<b>Hardwoods</b>			
Elm, Rock			
Oak, Red			
Oak, White			

## Moisture Removal Rates

### Moisture Removal Rate Per Day (Maximum)

These removal rates are estimates only. Always check your actual removal rates daily, using an accurate moisture meter. There are many variables that affect drying rates, such as how lumber is sawn, stacked, and how the chamber is built.

The following chart shows the calculated moisture removal rate per 24 hour period for an L200 Running at 100% .

Load Size	1000 BF	1500 BF	2000 BF	2500 BF	3000 BF	3500 BF	4000 BF
Group 1	13.7%	9.0%	6.7%	5.4%	4.5%	3.9%	3.4%
Group 2	9.3%	6.2%	4.6%	3.7%	3.1%	2.6%	2.3%
Group 3	8.5%	5.7%	4.3%	3.4%	2.8%	2.4%	2.1%

\* Drying rate may be too high, look at the maximum rates.

Drying Group 1 woods at a rate of less than 5% per day may result in mold or staining of the lumber.

Drying Group 3 woods at a rate greater than 3.5% per day may result in checking or other degrade to the lumber.

## L200 Drying Schedules

Group 1 woods generally do not have a maximum drying rate, you will want to remove the moisture quickly, and fast enough to avoid mold and stain. Set the Dry Bulb on 120°/Wet Bulb at 75°. The compressor will run constantly. You can turn the heat switch off once the temperature reaches 100°, Heat from the compressor motor and fan motors will keep the temperature rising. (At the end of the drying cycle, for softwoods, turn the compressor switch "OFF", and set the dry bulb temperature to 150° F. or 160° F. to set pitch.)

Moisture Content	Normal Schedule		Alternate Schedule	
	Dry Bulb	Wet Bulb	Dry Bulb	Wet Bulb
<b>Group 2</b>				
Above 45%	90° F	85° F	100° F	97° F
45% - 35%	100° F	87° F	105° F	93° F
35% - 25%	110° F	96° F	110° F	96° F
25% - Final	120° F	90° F	120° F	90° F
<b>Group 3</b>				
Above 45%	90° F	86° F	100° F	97° F
45% - 35%	100° F	96° F	105° F	101° F
35% - 25%	110° F	98° F	110° F	98° F
25% - Final	120° F	98° F	120° F	98° F
<b>Group 4</b>				
Above 50%	90° F	85° F	100° F	97° F
50% - 40%	95° F	89° F	100° F	96° F
40% - 35%	100° F	90° F	105° F	97° F
35% - 30%	110° F	98° F	110° F	98° F
30% - Final	120° F	95° F	120° F	95° F

Use the alternate schedules if you are in a warm climate or otherwise unable to maintain a 90° F dry bulb temperature at the beginning of the drying cycle.

## Drying Rates (North American Measure)

Species	Oven Dry Weight #/MBF	Avg. Green MC %	Green Weight #/MBF	# Water Per % MC	Max MC% Loss/ day
Cedar, Eastern White	1578	93	3046	16	11
Fir, Balsam	1739	118	3790	17	20
Hemlock, Eastern	2161	111	4558	22	20
Larch, Eastern	2532	52	3849	25	20
Pine, Red (Norway)	2051	83	3747	21	15
Pine, Eastern White	1950	90	3705	20	12
Spruce, Black	2110	80	3798	21	20
Spruce, Red	2000	89	3781	20	20
Spruce, White	1840	115	3967	18	20
Ash, Black	2532	95	4937	25	7
Ash, White	3055	45	4431	31	10.4
Basswood	1899	107	3933	19	12
Beech	3114	63	5089	31	4.5
Birch, White	2692	73	4659	27	10
Birch, Yellow	2954	69	4996	30	6.1
Cherry, Black	2633	58	4161	26	5.8
Elm, Rock	3165	50	4760	32	3.5
Elm, White	2692	93	5207	27	10.4
Hickory	3325	64	5452	33	6
Maple, Soft	2692	93	4389	27	13.8
Maple, Hard	3165	68	5317	32	6.5
Oak, Northern Red Upland	3277	74	5703	33	3.8
Oak, White Upland	3518	70	5981	35	2.5
Oak, Southern Red	3092	80	5567	31	3.8
Sweetgum (Red gum)	2740	100	5480	27	5.3
Walnut	2851	85	5274	29	8.2
Yellow Poplar, Cottonwood	1899	154	4819	19	13.8

Northeast Lumber - Based on 4/4 (1" or 25 mm)

To estimate maximum % MC loss per day for other thickness' multiply % MC loss per day from the above table by 0.6 for 6/4 and 0.4 for 8/4.

## Drying Rates (Metric)

Species	Oven Dry Weight Kg / M3	Avg. Green MC %	Green Weight Kg / M3	Kg Water Per % MC	Max MC% Loss/day
Cedar, Eastern White	315.6	93	609.2	7.27	11
Fir, Balsam	347.8	118	758	7.73	20
Hemlock, Eastern	432.2	111	911.6	10	20
Larch, Eastern	506.4	52	769.8	11.36	20
Pine, Red (Norway)	410.2	83	749.4	9.55	15
Pine, Eastern White	390	90	741	9.09	12
Spruce, Black	422	80	759.6	9.55	20
Spruce, Red	400	89	756.2	9.09	20
Spruce, White	368	115	793.4	8.18	20
Ash, Black	506.4	95	987.4	11.36	7
Ash, White	611	45	886.2	14.09	10.4
Basswood	379.8	107	786.6	8.64	12
Beech	622.8	63	1017.8	14.09	4.5
Birch, White	538.4	73	931.8	12.27	10
Birch, Yellow	590.8	69	999.2	13.64	6.1
Cherry, Black	526.6	58	832.2	11.82	5.8
Elm, Rock	633	50	952	14.55	3.5
Elm, White	538.4	93	1041.4	12.27	10
Hickory	655	64	1090.4	15	6
Maple, Soft	538.4	93	877.8	12.27	13.8
Maple, Hard	633	68	1063.4	14.55	6.5
Oak, Northern Red Upland	655.4	74	1140.6	15	3.8
Oak, White Upland	703.6	70	1196.2	15.91	2.5
Oak, Southern Red	618.4	80	1113.4	14.09	2
Sweetgum (Red gum)	548	100	1096	12.27	5.3
Walnut	570.2	85	1054.8	13.18	8.2
Yellow Poplar, Cottonwood	379.8	154	963.8	8.64	13.8

Northeast Lumber - Based on 4/4 (1" or 25 mm)

To estimate maximum % MC loss per day for other thickness' multiply % MC loss per day from the above table by 0.6 for 6/4 and 0.4 for 8/4.



## Kiln Sample Boards

It is best to use sample boards to measure moisture content on a daily basis. Moisture meters are not accurate enough for most hardwood dry kiln operations when the wood is above 30% MC and there is a need to keep a close watch on the drying rate. In Oak, for example, all checks and honeycombing occur when the wood is drying from green down to 40% MC, so that is when the drying rate needs to be closely controlled.

## Uses for Sample Boards

- To estimate the MC of the load in the chamber, so that kiln conditions can be regulated according to drying schedules.
- To measure the drying rate, which allows control of drying quality.
- To check on any degrade development.
- To check on final MC and drying stresses.
- To develop a MC vs. time curve.
- To study variations in drying within the kiln.
- To monitor changes in MC after drying (during storage and shipping) Note: It is a good idea to keep sample boards with dried lumber so that they can be used to track moisture content changes in storage.

## Taking Samples

1. Select sample boards. Keep in mind that they need to represent a “sample” of the lumber in the kiln. Do not select junk boards, and select both the slowest and the fastest drying boards of the load. Generally, you want six sample boards.
2. Cut 30” samples, at least 12” from the ends of each of the sample boards. Avoid having knots, splinters or bark in the sample.
3. Number the samples you cut.
4. Cut two 1” sections off each end of the samples, and mark them with the number of the board they came from.

**Example:** the two sections that came from sample board 3 would be labeled 3A and 3B.

5. Apply end coat to the 28” sample boards. This assures that the sample board will dry as though it were a larger piece of lumber.

End coatings are not usually required when lumber is placed in the kiln directly after being sawn. However when lumber is air dried prior to kiln drying, end coating is often helpful in preventing end checks

6. Weigh the 28” sample boards. An accuracy of .025 pounds or 1 gram is recommended. **Record these values.**
7. Put the 28” sample boards in the lumber stacks in places where they can be reached and will dry at the same rate as the lumber. **Do not place the sample boards where they will receive more air flow than the rest of the lumber.**
8. Take the “green weight” by weighing all the 1” sections, to 0.1 gram accuracy is suggested. **Record these values.**
9. Oven dry the 1” sections using one of the two methods below.

- **Microwave with carousel tray:** Put sections on a paper towel on the tray. Use low power (to avoid smoking) for 20 minutes. Weigh the section, and put back in the microwave for 1 minute. If the section has not lost any weight, it is oven dry. If still losing water, continue drying in 5 minute increments until a constant weight is achieved.
- **Oven:** Place the 1” section in an oven at 215°F (101°C) until the section stops losing weight, usually takes 24 hours. Check hourly until the section weighs the same in separate weighings.

10. Calculate the moisture content of each 1” section separately using the following formula:

$$\%MC = \left( \frac{\text{Wet Weight}}{\text{Oven Dry Weight}} - 1 \right) \times 100$$

11. Average the moisture content of the two 1" sections from each 28" sample board to calculate the estimated moisture content of the sample board when it was cut.

12. Calculate the oven dry weight of the 28" sample board is using the following formula and the average moisture content (MC) from the previous step:

$$\text{OD weight} = \left( \frac{\text{Wet Weight}}{100 + \%MC} \right) \times 100$$

13. Write the calculated OD weight on the sample board so that it is readily available.

14. At about the same time each day, weigh the sample boards and calculate the current moisture content with this formula:

$$\text{Current \%MC} = \left( \frac{\text{Current Weight}}{\text{Calculated Oven Dry Weight}} - 1 \right) \times 100$$

15. Place the 28" sample board back in the same place in the kiln it came from.

16. Calculate the daily drying rate for each section. Keep all the figures written down as a record of the load. Make any adjustments to the schedule based on the fastest drying sample.

17. Once the moisture content of the kiln is below 20%, it is often a good idea to cut new 1" sections from the center of the sample boards (1 section per board).

**Example:** Two 1" sections are cut from 30" sample board 1, and labeled 1A and 1B. They are weighed on a balance, and the weights are: A=2.5g and B=2.3g. The sections are placed in a microwave on low power for 20 minutes and weighed, weighing A=1.7g and B=1.6g. They are put back in the microwave for 1 minute and weighed again. The weights did not change, so these values are now oven dry weights.

- Calculate the moisture content using the formula in step 10.

$$A = [(2.5 / 1.7) - 1] \times 100 = 47.06 \quad B = [(2.3 / 1.6) - 1] \times 100 = 43.75$$

- Average the two calculations together:

$$(47.06 + 43.75) / 2 = 45.40\%$$

This is the calculated moisture content for the rest of the sample board.

- Calculate the oven dry weight of the sample board 1. Use the formula in step 11. The green weight is 1.64 kilograms.

$$\text{ODW} = (1.64 / 145.4) \times 100 = 1.13 \text{ kg.}$$

- After a day in the kiln, weigh sample board 1 and it weights 1.58 kg. Using the formula in step 13, the moisture content is:

$$\%MC = [(1.58 / 1.13) - 1] \times 100 = 39.8$$

- The daily change in moisture content is:

$$45.4 - 39.8 = 5.6\%.$$

## Record Keeping

A good system of record keeping for the dry kiln is essential to developing a good operating procedure. The records that are kept will indicate when operations are deviating from the norm and will allow future schedules to alter to improve production.

**Note:** It is recommended that all information be kept on the sample boards as outlined in the Dry Kiln Operator's Manual.

In addition to the records kept daily on the sample boards, it is also very important to plot on a graph the average and wettest drying sample. If possible, plot all the samples on the graph. This will indicate the drying rate and often any adjustment will become apparent on the graph before it is analyzed in the data.

Each day, the water removal should be weighed for one minute and that figure recorded on the kiln records. While one direct use is made of this information in the drying schedule, a deviation from normally expected water flows will give early warning of a malfunction in the refrigeration system.

Several times during the cycle the bulb should be measured on both sides of the load and in several areas. The average should be noted on the kiln record. As with measuring the water removal rate, this is not used in the operation of the kiln but

deviations from normal will indicate a problem in loading, baffling, airflow etc. That will affect drying. These figures will always vary but being familiar with them, the operator will be able to detect a malfunction early.

Record should be kept for comparison throughout the year. It is wise to compare summer loads with summer and winter loads.

## Drying Rate Index (DRI)

The dry kiln industry has never had a method of predicting drying rates. This is remarkable as one main reason for having a kiln is to bring about predictable production rates. The EMC value gives an end point of what the moisture content of the lumber would eventually become but it does not give an indication of how long it will take to reach that moisture content.

Drying schedules for dehumidification drying were developed in the late 1970's. It became obvious that a method of adjusting kiln schedules to meet drying time objectives within the limitations of the operation range of the dehumidifiers had to be found. It was common to look up a drying schedule in the Dry Kiln Operators Manual or some other reference, and then find a set of conditions at which dehumidifier could run using the same EMC. This resulted in unnecessarily long drying cycles and was quickly shown to be an ineffective method of doing kiln schedules.

Nyle developed the Drying Rate Index in response to that but time has shown that the Drying Rate Index is very useful in both conventional and dehumidification kilns. With the trend to control kilns by monitoring drying rate to get maximum productivity and quality, the Drying Index becomes a very valuable tool.

The drying rate is a function of the vapor pressure deficit. Everyone knows that things dry faster in hotter, drier air. Every fluid has a vapor pressure associated with it that varies with the temperature of the fluid. Air has a vapor pressure that is of function of temperature and humidity. The difference between the two determines the rate drying. This is how everything in the world dries whether it is paint, the ocean, the lumber or perspiration. When the humidity of the air is 100% no evaporation takes place regardless of the temperature. As relative

humidity drops the rate the fluid evaporates increases. The problem is that a way of predicting the change in drying rate with changes in temperature and humidity was needed.

**The Drying Rate Index is a relative number.**

**Example:** A kiln is operating at 120° F. dry bulb and 110° F. wet bulb, that means the depression is:

10° (120° F.- 110° F. = 10° F.) According to the Nyle Drying Chart, The relative humidity is 72% the Equilibrium Moisture Content (EMC) is 12.1% and the Drying Rate Index (DRI) is 1.0. The EMC indicates where the lumber will end eventually. The EMC is also an indication of where the surface moisture content of the lumber will go fairly quickly. The whole board will eventually be 12.1 % but the surface will reach 12.1% much quicker.

In the above example, the lumber might be drying at 3% per day but it could be dried faster at 5% per day. In order to change the drying rate from 3% per day to 5% per day, it would be necessary to find a DRI that is 1.67 times the existing drying rate.

Desired Drying Rate/Existing Drying Rate = Multiplier.  
(5/3=1.67)

Multiplier x Existing DRI= Desired DRI

The existing DRI is 0.9 so the new DRI should be 1.5  
(0.9 x 1.67)

Referring to the Nyle Drying Chart (Pg 27), it can be seen that if the temperature were increased to 130° F and the depression 13° F (read between 12 and 14 on the chart), the DRI will be 1.5. Other combinations of dry bulb and depression will give the same result.

**Example:** Dry bulb could be left at 120° F and the depression increased to 17° F, or the dry bulb could be raised to 140° F. and the depression left at 10° F. All of these would result in a 1.5 DRI and thus would dry the lumber at 5% per day.

**Note:** The above three choices, 130/13, 120/17 and 140/10, the EMC is 10.5, 9.1 and 11.9 respectively. It is clear that EMC has nothing to do with how fast lumber dries but it does mean that low temperatures and bigger depressions may mean the surface moisture content will be lower. In some cases, were this pressed to an extreme, it may make the surface

shrink too much so that factor should be considered.

The best way to use the drying chart is to check the kiln each day. Calculate the moisture loss and then adjust the kiln temperature and humidity each day to achieve the drying rate desired. Each charge of lumber will be different and will result in a different drying schedule. For this reason, it will be clear that drying schedules are of little use except as a starting point. None of the drying schedule published state at what airflow they were developed. So running a schedule from a manual or another operation is ineffective as the airflow in the kiln may be different and may change through the cycle if variable speed fans are used.

## Drying Tips

- Fresh cut lumber dries better and is less likely to be damaged during the drying process. Try to get it in the kiln as soon as possible.
  - If you can't dry your lumber immediately after its been cut make sure that it is stacked, stickered and stored in a clean, dry place. Monitor it until it is ready to be put in the kiln as its moisture content will change during this time.
  - Carefully plan your drying schedules for every batch of lumber and follow through with them, only making alterations when necessary. Neglecting an effective schedule can ruin product and cost you money.
  - Air flowing through the lumber will be removing the moisture. Make sure you take the time to properly sticker and stack your lumber in the kiln. Better airflow will result in better drying.
  - Use baffles and deflectors to control airflow inside the kiln when drying, it will be more efficient and result in more evenly dried lumber.
  - Keep detailed records of every batch. If necessary you can use them as a reference when making improvements in scheduling or correcting mistakes.
  - Make sure that an operator is always available when drying so that any necessary adjustments can be made as soon as possible. This will reduce the chance of any major issues during the process.
- Always double check your numbers at the end of a schedule to make sure that you have achieved your desired result.
  - Every detail is important when drying lumber. Make sure that you are following operation and safety guidelines. Cutting corners can ruin your product, damage your unit, or even cause injury.
  - If you are unsure about any aspect of operation or if something seems to be working incorrectly please contact Nyle as soon as possible. **Do not continue operation, attempt any adjustment or repair to a unit with out consulting a licensed professional.**
  - Once a batch of lumber is dried keep it in a clean, dry location, away from the elements. Ideally kept inside and off the ground.
  - Always stay up to date with the latest information on lumber drying. Attend trainings and seminars whenever possible and keep in contact with your local forestry offices

# Nyle Drying Chart

Wet Bulb Depression [Dry Bulb - Wet Bulb] °F

DryBulb °F	Measurement	2°	4°	6°	8°	10°	12°	14°	16°	18°	20°	25°	30°	35°	40°	45°	50°	
30°	RH	78.0	57.0	36.0	17.0													
	EMC	15.9	10.8	7.4	3.9													
	DRI	0.0	0.1	0.1	0.1													
35°	RH	81.0	63.0	45.0	28.0	11.0												
	EMC	16.8	11.9	8.8	6.0	2.9												
	DRI	0.0	0.1	0.1	0.1	0.2												
40°	RH	83.0	68.0	52.0	37.0	22.0	8.0											
	EMC	17.6	12.9	9.9	7.4	5.0	1.9											
	DRI	0.0	0.1	0.1	0.2	0.2	0.2											
45°	RH	85.0	72.0	58.0	44.0	31.0	19.0	6.0										
	EMC	18.3	13.7	10.7	8.5	6.5	4.2	1.5										
	DRI	0.0	0.1	0.1	0.2	0.2	0.2	0.3										
50°	RH	86.0	74.0	62.0	50.0	38.0	27.0	16.0	5.0									
	EMC	19.0	14.4	11.5	9.4	7.6	5.7	3.9	1.5									
	DRI	0.1	0.1	0.1	0.2	0.2	0.3	0.3	0.3									
55°	RH	88.0	76.0	65.0	54.0	44.0	34.0	24.0	14.0	5.0								
	EMC	19.5	15.1	12.2	10.1	8.4	6.8	7.3	3.6	1.3								
	DRI	0.1	0.1	0.2	0.2	0.2	0.3	0.3	0.4	0.4								
60°	RH	89.0	78.0	68.0	58.0	48.0	39.0	30.0	21.0	13.0	5.0							
	EMC	19.9	15.6	12.7	10.7	9.1	7.6	6.3	4.9	3.2	1.3							
	DRI	0.1	0.1	0.2	0.2	0.3	0.3	0.4	0.5	0.5	0.5							
65°	RH	90.0	80.0	70.0	61.0	52.0	44.0	36.0	27.0	20.0	13.0							
	EMC	20.3	16.1	13.3	11.2	9.7	8.3	7.1	5.8	4.5	3.0							
	DRI	0.1	0.1	0.2	0.2	0.3	0.3	0.4	0.5	0.5	0.5							
70°	RH	90.0	81.0	72.0	64.0	55.0	48.0	40.0	33.0	25.0	19.0	3.0						
	EMC	20.6	16.5	13.2	11.6	10.1	8.8	7.7	6.6	5.5	4.3	0.7						
	DRI	0.1	0.1	0.2	0.3	0.3	0.4	0.4	0.5	0.6	0.6	0.7						
75°	RH	91.0	82.0	74.0	66.0	58.0	51.0	44.0	37.0	31.0	24.0	10.0						
	EMC	20.6	16.8	14.0	12.0	10.5	9.3	8.2	7.2	6.2	5.1	2.3						
	DRI	0.1	0.2	0.2	0.3	0.4	0.4	0.5	0.6	0.6	0.7	0.8						
80°	RH	91.0	83.0	75.0	68.0	61.0	54.0	47.0	41.0	35.0	29.0	15.0	3.0					
	EMC	21.0	17.0	14.3	12.3	10.9	9.7	8.6	7.7	6.8	5.8	3.5	0.3					
	DRI	0.1	0.2	0.3	0.3	0.4	0.5	0.5	0.6	0.7	0.7	0.9	1.0					
85°	RH	92.0	84.0	76.0	70.0	63.0	56.0	50.0	44.0	38.0	33.0	20.0	9.0					
	EMC	21.2	17.2	14.5	12.5	11.2	10.0	9.0	8.1	7.2	6.3	4.3	1.7					
	DRI	0.1	0.2	0.3	0.4	0.4	0.5	0.6	0.7	0.8	0.8	1.0	1.1					
90°	RH	92.0	85.0	78.0	71.0	65.0	58.0	52.0	47.0	41.0	36.0	24.0	13.0	3.0				
	EMC	21.3	17.3	14.7	12.8	11.4	10.2	9.3	8.4	7.6	6.8	4.9	2.8	0.9				
	DRI	0.1	0.2	0.3	0.4	0.5	0.6	0.7	0.8	0.8	0.9	1.1	1.2	1.4				
95°	RH	92.0	85.0	79.0	72.0	66.0	60.0	55.0	49.0	44.0	39.0	28.0	17.0	8.0				
	EMC	21.3	17.4	14.9	12.9	11.6	10.5	9.5	8.7	7.9	7.1	5.3	3.6	1.9				
	DRI	0.1	0.2	0.3	0.5	0.6	0.7	0.7	0.8	0.9	1.0	1.2	1.4	1.5				
100°	RH	93.0	86.0	80.0	73.0	68.0	62.0	56.0	51.0	46.0	41.0	30.0	21.0	12.0	4.0			
	EMC	21.3	17.5	15.0	13.1	11.8	10.6	9.6	8.9	8.1	7.4	5.7	4.2	2.8	0.7			
	DRI	0.1	0.3	0.4	0.5	0.6	0.7	0.9	0.9	0.9	1.0	1.1	1.4	1.5	1.7	1.9		

DryBulb °F	2°	4°	6°	8°	10°	12°	14°	16°	18°	20°	25°	30°	35°	40°	45°	50°
105°	RH	93.0	87.0	80.0	74.0	69.0	63.0	58.0	53.0	48.0	44.0	34.0	24.0	16.0	8.0	
	EMC	21.4	17.5	15.1	13.2	11.9	10.8	9.8	9.0	8.3	7.6	6.1	4.6	3.3	1.8	
	DRI	0.2	0.3	0.4	0.6	0.7	0.8	0.9	1.1	1.2	1.3	1.5	1.7	1.9	2.1	
110°	RH	93.0	87.0	81.0	75.0	70.0	65.0	60.0	55.0	50.0	46.0	36.0	26.0	19.0	11.0	4.0
	EMC	21.4	17.5	15.1	13.3	12.0	10.8	9.9	9.2	8.4	7.7	6.3	4.8	3.8	2.5	1.1
	DRI	0.2	0.3	0.5	0.6	0.8	0.9	1.0	1.2	1.3	1.4	1.7	1.9	2.1	2.3	2.5
115°	RH	93.0	88.0	82.0	76.0	66.0	61.0	56.0	52.0	48.0	38.0	29.0	22.0	14.0	8.0	2.0
	EMC	21.4	17.5	15.1	13.4	12.1	10.9	10.0	9.3	8.6	7.8	6.5	5.2	4.1	2.9	1.7
	DRI	0.2	0.4	0.5	0.7	0.9	1.0	1.2	1.3	1.4	1.6	1.9	2.1	2.4	2.6	2.8
120°	RH	94.0	88.0	82.0	77.0	72.0	67.0	62.0	58.0	53.0	49.0	40.0	31.0	24.0	17.0	10.0
	EMC	21.3	17.4	15.1	13.4	12.1	11.0	10.0	9.4	8.7	7.9	6.6	5.4	4.4	3.3	2.3
	DRI	0.2	0.4	0.6	0.8	1.0	1.1	1.3	1.4	1.6	1.8	2.1	2.4	2.6	2.9	3.1
125°	RH	94.0	88.0	83.0	77.0	73.0	68.0	63.0	59.0	55.0	51.0	41.0	33.0	26.0	19.0	13.0
	EMC	21.2	17.3	15.0	13.4	12.1	11.0	10.0	9.4	8.7	8.0	6.7	5.5	4.6	3.6	2.7
	DRI	0.2	0.5	0.7	0.9	1.1	1.3	1.5	1.6	1.8	1.9	2.3	2.7	2.9	3.2	3.4
130°	RH	94.0	89.0	83.0	78.0	73.0	69.0	64.0	60.0	56.0	52.0	43.0	35.0	28.0	21.0	15.0
	EMC	21.0	18.2	14.9	13.4	12.1	11.0	10.0	9.4	8.7	8.0	6.8	5.6	4.8	3.8	3.0
	DRI	0.3	0.5	0.8	1.0	1.1	1.4	1.6	1.8	2.0	2.2	2.6	2.9	3.3	3.6	3.9
140°	RH	95.0	89.0	84.0	79.0	75.0	70.0	66.0	62.0	58.0	54.0	46.0	38.0	31.0	25.0	19.0
	EMC	1.0	16.9	14.8	13.2	11.9	10.6	10.0	9.4	8.7	8.0	6.9	5.8	5.0	4.1	3.4
	DRI	0.3	0.6	0.9	1.2	1.5	1.8	2.0	2.2	2.5	2.7	3.2	3.7	4.1	4.4	4.8
150°	RH	95.0	90.0	85.0	80.0	76.0	72.0	68.0	64.0	60.0	57.0	48.0	41.0	35.0	28.0	23.0
	EMC	20.2	16.9	14.5	13.0	11.8	10.8	9.9	9.2	8.6	8.0	6.9	5.8	5.1	4.2	3.6
	DRI	0.4	0.8	1.1	1.5	1.8	2.1	2.4	2.7	3.0	3.3	3.9	4.5	5.0	5.5	5.8
160°	RH	95.0	90.0	86.0	81.0	77.0	73.0	69.0	65.0	62.0	58.0	50.0	43.0	37.0	31.0	25.0
	EMC	19.8	16.2	14.2	12.7	11.5	10.6	9.7	9.1	8.5	7.9	6.8	5.8	5.1	4.3	3.7
	DRI	0.5	1.0	1.4	1.8	2.2	2.6	3.0	3.4	3.7	4.1	4.8	5.5	6.1	6.7	7.2
170°	RH	95.0	91.0	86.0	82.0	78.0	74.0	70.0	67.0	63.0	60.0	52.0	45.0	39.0	33.0	28.0
	EMC	19.4	15.8	13.9	12.4	11.3	10.4	9.6	9.0	8.4	7.8	6.7	5.7	5.1	4.4	3.7
	DRI	0.6	1.1	1.7	2.2	2.7	3.2	3.7	4.0	4.5	4.9	5.9	6.7	7.5	8.2	8.8
180°	RH	96.0	91.0	87.0	83.0	79.0	75.0	72.0	68.0	65.0	62.0	54.0	47.0	41.0	35.0	30.0
	EMC	18.9	15.5	13.7	12.2	11.1	10.1	9.4	8.8	8.1	7.6	6.5	5.7	5.1	4.4	3.8
	DRI	0.6	1.4	2.0	2.6	3.2	3.8	4.3	4.9	5.4	5.8	7.0	8.1	9.0	10.0	10.7
190°	RH	96.0	92.0	88.0	84.0	80.0	76.0	73.0	69.0	66.0	63.0	56.0	49.0	43.0	37.0	32.0
	EMC	18.5	15.2	13.4	12.0	10.9	10.0	9.2	8.6	7.9	7.4	6.4	5.5	4.9	4.4	3.8
	DRI	0.8	1.5	2.3	3.0	3.8	4.6	5.1	5.9	6.5	7.0	8.4	9.7	10.9	12.0	12.9
200°	RH	96.0	92.0	88.0	84.0	80.0	77.0	84.0	80.0	77.0	64.0	57.0	51.0	45.0	39.0	34.0
	EMC	18.1	14.9	13.2	11.8	10.8	9.8	9.1	8.4	7.7	7.2	6.2	5.4	4.8	4.3	3.8
	DRI	0.9	1.9	2.8	3.8	4.7	5.4	6.1	7.0	7.8	8.5	10.1	11.5	13.0	14.3	15.5
210°	RH	96.0	92.0	88.0	85.0	81.0	78.0	75.0	71.0	68.0	65.0	59.0	52.0	46.0	41.0	36.0
	EMC	17.7	14.6	13.0	11.7	10.6	9.7	9.0	8.3	7.6	7.1	6.1	5.3	4.7	4.2	3.7
	DRI	1.2	2.3	3.5	4.3	5.5	6.3	7.2	8.3	9.2	10.1	11.8	16.8	15.5	17.0	18.4

# Kiln Cart

## Kiln Cart Layout

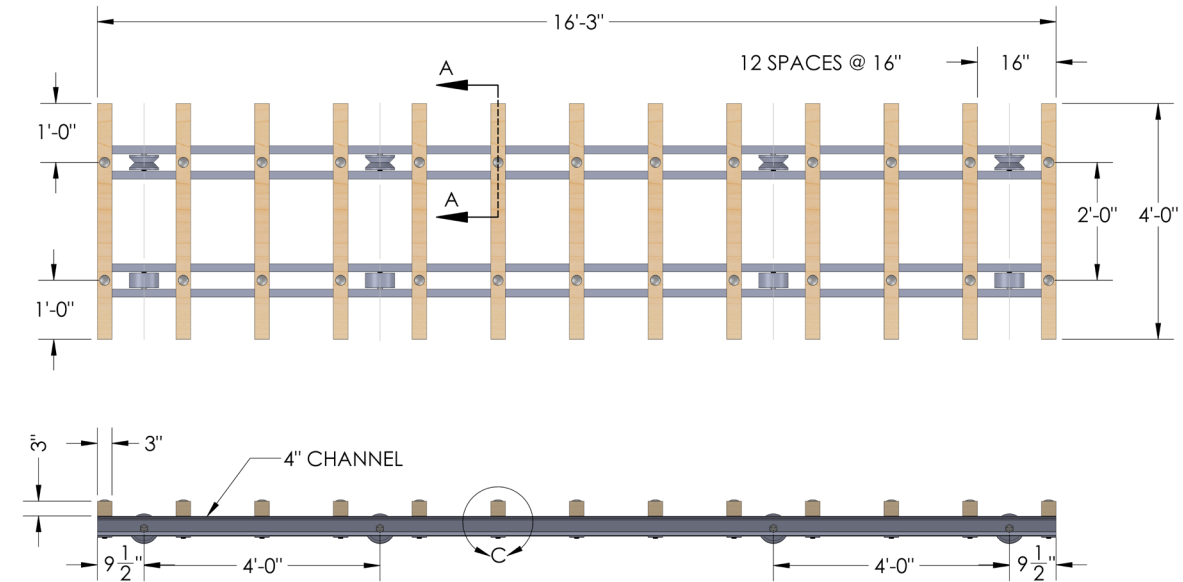

**TWO KILN CARTS REQUIRED FOR A 40' CONTAINER**

USE HARDWOOD FOR CROSS PIECES IF DRYING SPECIES SUCH AS OAK THAT ARE SUSCEPTIBLE TO STAINING. OTHERWISE STEEL MAY BE USED.

SPACE CROSS PIECES TO MATCH STICKERING PRACTICE

## Kiln Cart Assembly

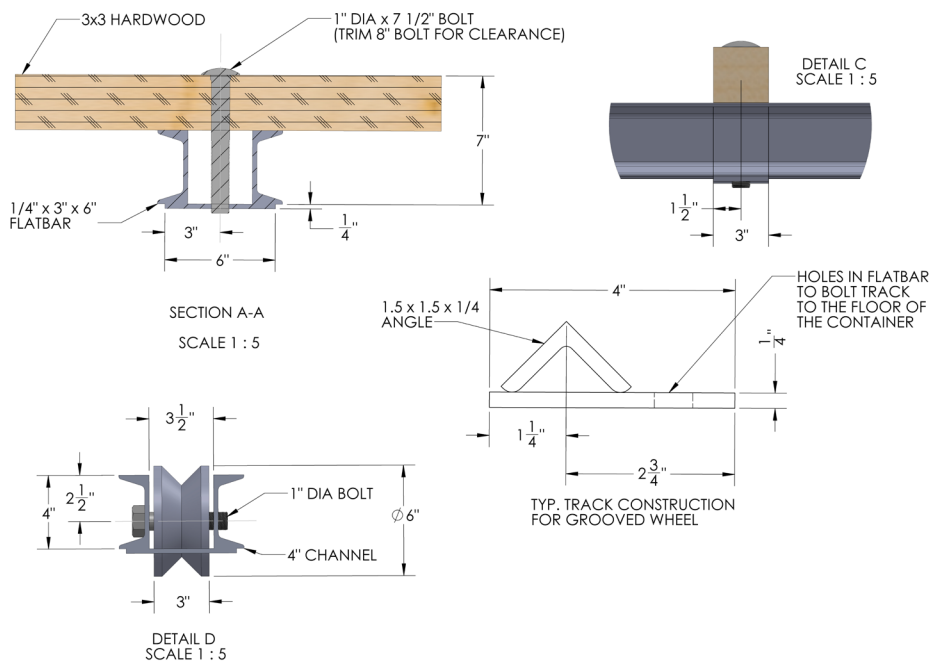

# Wiring Diagrams

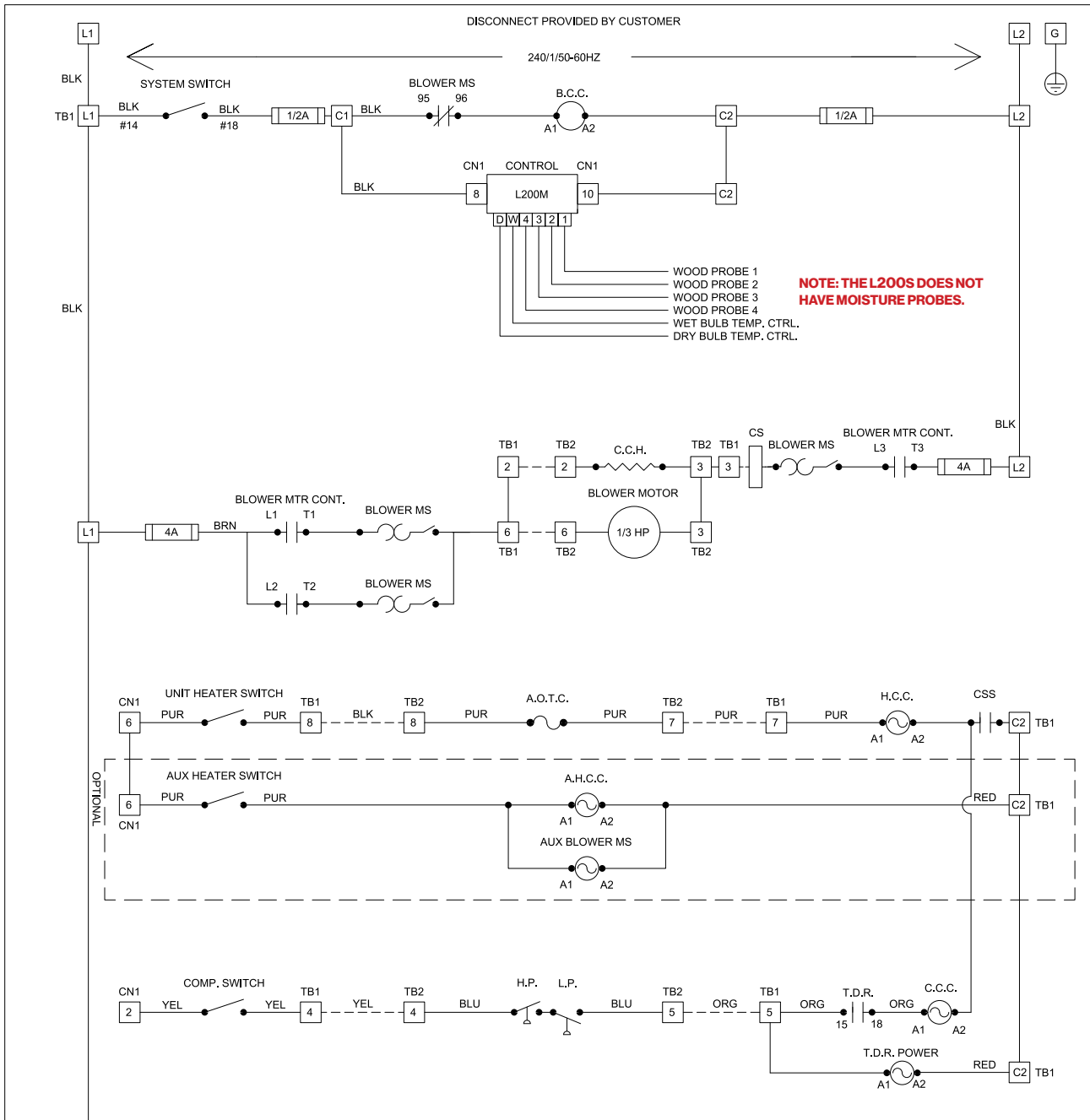

**NOTE: THE L200S DOES NOT HAVE MOISTURE PROBES.**

**LEGEND:**

- TB1 - CONTROL BOX
- TB2 - COMP. UNIT
- TB3 - AUX HEAT TERMINAL BLOCK
- CN1 - LOGICA TERMINAL BLOCK
- CN2 - LOGICA TERMINAL FOR SENSORS
- A.O.T.C. - AUTOMATIC OVER TEMPERATURE CONTROL
- H.C.C. - HEATER CONTACTOR COIL
- A.H.C.C. - AUX HEATER CONTACTOR COIL
- C.C.C. - COMPRESSOR COIL
- H.P. - HIGH PRESSURE SWITCH
- L.P. - LOW PRESSURE SWITCH
- C.C.H. - CRANK CASE HEATER
- T.D.R. - TIME DELAY RELAY
- A.O.T.C. - AUTOMATIC OVER TEMPERATURE SWITCH
- CS - CURRENT SENSOR
- CSS - CURRENT SENSOR SWITCH
- FACTORY WIRING
- - - FIELD WIRING
- G GROUND

<p style="font-size: 8px; margin-top: 5px;">12 Stevens Road Brewer, Maine 04412 Tel: 1-207-989-4335 Int'l: 1-800-777-6953 Fax: 1-207-989-1101 Email: info@nyle.com</p>	<b>TITLE</b> POWER AND CONTROL WIRING	
	<b>CUSTOMER</b> L200M	
DRAWN BY <b>AS</b>	DWG FILE NAME L200M CE	REV <b>2021.1.3</b>
CHECKED	SCALE NTS	SHEET 1 OF 2



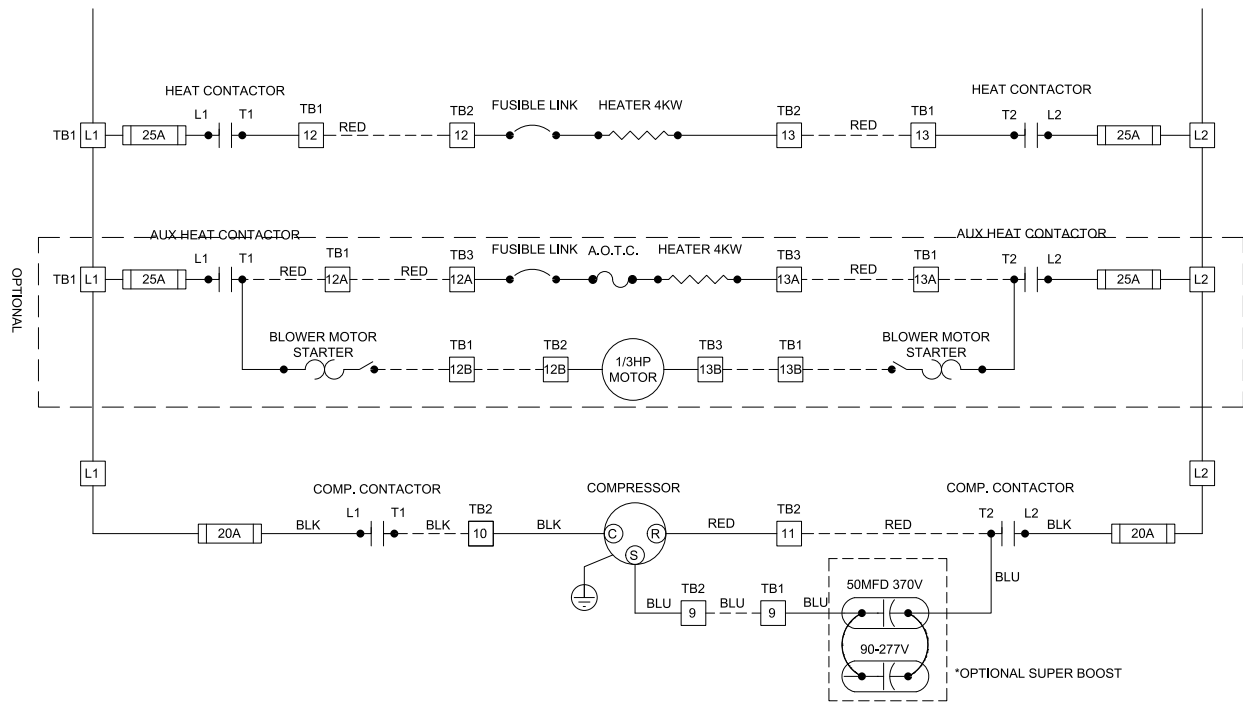

OPTIONAL

\*OPTIONAL SUPER BOOST

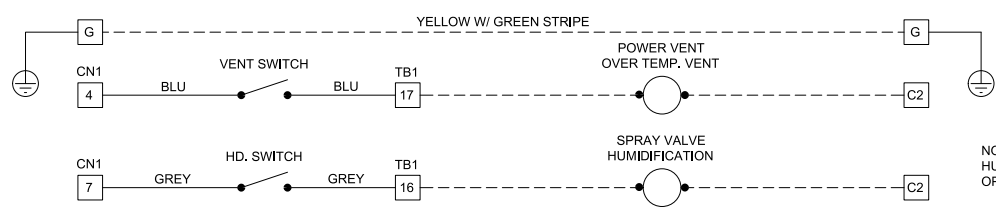

NOTE: POWER VENT AND HUMIDIFICATION ARE OPTIONAL ADD-ONS

LEGEND:

- TB1 - MASTER CONTROL BOX
- TB2 - MASTER COMP. UNIT
- TB3 - SLAVE CONTROL BOX
- TB4 - SLAVE COMP. UNIT
- CN1 - L200 TERMINAL BLOCK
- CN2 - L200 TERMINAL FOR SENSORS
- A.O.T.C. - AUTOMATIC OVER TEMPERATURE CONTROL
- H.C.C. - HEATER CONTACTOR COIL
- C.C.C. - COMPRESSOR COIL
- H.P. - HIGH PRESSURE SWITCH
- L.P. - LOW PRESSURE SWITCH
- C.C.H. - CRANK CASE HEATER
- T.D.R. - TIME DELAY RELAY
- A.O.T.C. - AUTOMATIC OVER TEMPERATURE SWITCH
- FACTORY WIRING
- FIELD WIRING
- G GROUND

 12 Stevens Road Brewer, Maine 04412 Tel: 1-207-989-4335 Int'l: 1-800-777-6953 Fax: 1-207-989-1101 Email: info@ny/e.com	TITLE <b>POWER AND CONTROL WIRING</b>	
	CUSTOMER <b>L200M</b>	
DRAWN BY <b>AS</b>	DWG FILE NAME <b>L200M CE</b>	REV <b>2021.1.3</b>
CHECKED	SCALE <b>NTS</b>	SHEET <b>2 OF 2</b>

# L200 Maintenance

## General Maintenance

The L200 is designed for continuous duty, with little maintenance. However, when a problem does arise prompt repair will ensure long life for the machine.

The blower system is direct drive and the motor has sealed high temperature ball bearings. This unit does not need regular maintenance.

The circulating fan system is also direct drive with a ball bearing motor. The motor does not require lubrication.

## Air Inlet Filters

The air filters are provided to keep the air inside the unit as clean as possible. Dirt build-up on the coils will lead to poor heat transfer with loss of capacity.

In extreme cases, the coil will completely clog. The air filter should be washed when dirty and replaced when necessary. If the filter becomes clogged, the air supply will be drastically reduced, causing the heater to overheat and the refrigeration system to overload. Evap coil should be kept clean. Clean with dish soap and water.

## Refrigerant Charging Procedure

The refrigeration system is a closed loop system with its own lubrication oil supply. Nyle uses only the best trade practices when assembling these systems. The system should give years of trouble free service. However, if the system is not removing the right amount of water, or if a problem should arise from rough shipping or a refrigeration leak, the system should only be looked at and worked on by a qualified refrigeration mechanic.

When the system experiences reduced water output, this is generally associated with a leak in the refrigeration system. If the leak is found and repaired before the system is empty, there is little chance that the system will be contaminated with moisture. If the system is ignored for a long period of time, moisture can enter the system and combine with the refrigerant to form acid. The system will then corrode from the inside-out if not corrected properly.

**Warning: Refrigeration professionals should use caution, these refrigeration conditions are uncommon.**

These systems operate over a very wide temperature and humidity range. The pressures will be relatively high when compared to air conditioners and heat pumps. For these reasons, you cannot charge by the sight glass, the sight glass will eventually clear at certain conditions but it is unlikely that those conditions will exist when servicing.

If the kiln is loaded with lumber, it will be very dangerous to run the kiln at extreme limits, as the lumber will degrade severely. With this danger factor and the factor of time involved of heating the kiln, Nyle insists that these machines have weighed in charge. The amount is as follows:

**L200 60 oz. R134a**

**CALL NYLE IF YOUR TECHNICIAN LACKS THE RECOMMENDED REFRIGERANT. WE CAN RECOMMEND ALTERNATIVES.**

## Controller Factory Settings

These settings are programmed by Nyle before unit ships, and are provided for reference only. **Please do not attempt to adjust these settings without consulting Nyle service first.**

To enter the Initial Setup mode, hold the "Select" key and immediately hold the down arrow to enter in "Setup" mode, then release both the "Select" and down arrow; the first parameter setting screen will appear. To set the next parameters press the "Select" key again.

**Note:** The controller will automatically exit from the configuration mode after setting the last parameter or 10 seconds without any activity on the keyboard

1. Fahrenheit mode (on/off)

**Screen Appearance:** SETUP 1

Fahrenheit ON/OFF

If the parameter is set to ON, the temperature will be displayed in Fahrenheit, otherwise it will be displayed in Celsius degrees.

2. Compressor enabling temperature

(20°C to 99°C/68°F to 210°F)

**Screen Appearance:** SETUP 2

COMPRESSOR 80° F

It is the minimum temperature required to enable the compressor. Below this temperature the compressor will remain turned off.

3. Compressor hysteresis (0 to 20° C/F)

**Screen Appearance:** SETUP 3

Hy COMPRESSOR 1° F

This parameter is used to define a range around the WB temperature setting where the status (On or Off) of the compressor is left unchanged. This is useful to prevent undesired oscillations due to the measurement precision or to small fluctuations around the threshold values (see "Relay activation conditions").

4. Overheating threshold (0 to 20° C/F)

**Screen Appearance:** SETUP 4

Hy VENT 2° F

It defines a threshold above the DB temperature setting to activate the overheating relay. The relay is turned OFF when the DB temperature decrease to the DB set point (see "Relay activation conditions").

5. Humidification hysteresis (0 to 20° C/F)

**Screen Appearance:** SETUP 5

Hy SPRAY 2° F

This parameter is used to define a range around the WB temperature setting where the status (On or Off) of the humidification relay is left unchanged. This is useful to prevent undesired oscillations due to the measurement precision or to small fluctuations around the threshold values (see "Relay activation conditions").

6. Temperature hysteresis (0 to 20)

**Screen Appearance:** SETUP 6

Hy Temperature 1° F

This parameter is used to define a range around the DB temperature setting where the status (On or Off) of the heating relay is left unchanged. This

is useful to prevent undesired oscillations due to the measurement precision or to small fluctuations around the threshold values (see "Relay activation conditions").

11. Serial Address (0 to 128) (L53 Only)

**Screen Appearance:** SETUP 11

Serial Add x

It is used to assign a unique identification to the controller when it is connected to a PC. Each kiln of the plant must have a different address. The address numbers assigned should be consecutive starting from 1.

## Appendix

### Terminology

**DRY BULB:** The temperature as measured by a thermometer.

**WET BULB:** The temperature of a thermometer with a wet wick over the sensor.

**WET BULB DEPRESSION:** The difference between the dry bulb temperature and the wet bulb temperature.

**Example:** if the dry bulb is 105° F. and the wet bulb is 98° F., the depression is 105° F. - 98° F., or 7° F.

**RH-RELATIVE HUMIDITY:** The ratio of the amount of water in the air to what the air could hold. At 50% RH, the air has 50% as much water in it as it would hold at 100% RH. 100% is a 0° F. depression.

**EMC-EQUILIBRIUM MOISTURE CONTENT:** This is the average moisture content all wood will reach eventually when exposed to these conditions.

**Example:** At a dry bulb of 115° F. and a wet bulb of 101° F., a 14° F. depression, the EMC is 10%. This means that eventually all wood will average 10%. Wood drier than 10% will pick up water and wood that is wetter than 10% will give up water.

**DRI-DRYING RATE INDEX:** This is an index of relative drying rate.

**Example:** If a dryer is operating at 120° F. and a wet bulb depression of 12° F., and drying the load at a rate of 1.5% per day, at the DRI is 1.1. If the wood will dry at 2 times the rate ( $2.2/1.1=2$ ), or 3% per day. This assumes that other conditions remain the same.

## Problem

## Possible Causes / Actions

## Corrections

Problem	Possible Causes / Actions	Corrections
<b>Circulating Fan(s) won't Start</b>	<ul style="list-style-type: none"><li>• New Install: Check your wiring</li><li>• Existing System: Check your amp draw</li><li>• Check motor rotation for signs of sticking or grinding.</li></ul>	<ul style="list-style-type: none"><li>• Rewire or tighten connections.</li><li>• If amps are high: check capacitors, replace if needed.</li><li>• If rotation is sticking or grinding, bearings or bushing are bad, replace motor.</li></ul>
<b>Unit won't Start</b>	<ul style="list-style-type: none"><li>• Control Switch Tripping</li><li>• Check Power</li></ul>	<ul style="list-style-type: none"><li>• Rewire or tighten connections.</li><li>• Check capacitors, replace if needed.</li><li>• If Switch keeps tripping, replace switch.</li></ul>
<b>No Heat</b>	<ul style="list-style-type: none"><li>• Check that the automatic over temperature control switch (AOTC) is in auto position &amp; the control is calling for heat, use wiring diagram to check heat circuit.</li><li>• Check fusible link</li><li>• Check heater coil</li></ul>	<ul style="list-style-type: none"><li>• Replace the AOTC or fusible link if bad.</li><li>• Replace whole heater if coil is bad.</li></ul>
<b>Compressor doesn't run</b>	<ul style="list-style-type: none"><li>• High Pressure Switch has tripped</li><li>• Fault in circuit</li></ul>	<ul style="list-style-type: none"><li>• Reset High Pressure Switch.</li><li>• With a multimeter and wiring diagram check if:<ul style="list-style-type: none"><li>• Low Pressure switch tripped ; call nyle.</li><li>• Time delay relay is bad; Replace if it is.</li><li>• Compressor has power ; call nyle if it does.</li></ul></li></ul>
<b>Unit Starts and Runs but Screen is Dead</b>	<ul style="list-style-type: none"><li>• Bad fuse in controller</li></ul>	<ul style="list-style-type: none"><li>• Check fuse if fuse is bad, call nyle.</li></ul>
<b>Water isn't Draining</b>	<ul style="list-style-type: none"><li>• Issue with drain line/ trap</li></ul>	<ul style="list-style-type: none"><li>• Clear any blockages in drain line / trap.</li><li>• Add trap to drain line if no trap installed.</li></ul>
<b>Temperature is flashing ERR or both Wet &amp; Dry Bulb</b>	<ul style="list-style-type: none"><li>• Wet bulb too high</li><li>• Wet bulb equals Dry bulb</li></ul>	<ul style="list-style-type: none"><li>• Check Wet bulb bottle for water.</li><li>• Check Wet bulb wick.</li><li>• Make sure Wet bulb temperature doesn't equal Dry Bulb Temp.</li></ul>



**Still need help? Check out our video series KilnTECH on YouTube for more support.**



**Automatic Over Temperature Control Switch (AOTC)**

**Fusible Link**

## L200 Upgrades & Accessories

### Spray Systems Kit

Although not standard on Nyle DH Kilns you may choose to add on this optional Spray System Kit which will provide extra control when drying. The Sprayers are designed to be automatically activated by the system when needed and help with regulating the relative humidity within the kiln chamber.

Nyle spray systems are designed to inject into kiln air one gallon of water per hour for every 1000 BF. Because air temperature affects the quantity of water evaporated (warmer air holds more water vapor), we need to balance the quantity of water vapor to the kiln capacity. DH units with small heaters will require proportionately less water than larger units with bigger heating capacity. There are options available for every unit so be sure that the kit you are purchasing matches the specifications for the unit that it will be installed in.

Nyle encourages boosting water pressure to 100 psi for the spray system to have the best results. Commonly this is done with the use of a jet pump, which can be purchased through Nyle if requested. Contact your Nyle Sales or Service Representative for more information. You can reach a Nyle Service Professional by:

Calling us directly at (800)777-6953 X 212 or by sending us an email at [service@nyle.com](mailto:service@nyle.com)

### Heat Booster Packages



The Heat Booster is an auxiliary heater that can be connected to the control and provide additional heat and airflow within the kiln. This upgrade is used to;

**Set Pitch:** The heat booster allows the kiln temperature to reach 160° F to set the pitch and prevent any future running.

**Note:** Pitch setting is only required when drying Pine.

**Sterilize the Load:** By the kiln reaching 160° F it also sterilizes the load. During this sterilization process any bugs or mold in the wood is killed off.

The heat booster is also used to increase the speed at which the kiln chamber heats to the desired temperature. This becomes useful for when you have a larger chambers.

CONTROL ROOM ASSEMBLY OF SOLENOID VALVE, STRAINER, AND REGULATOR

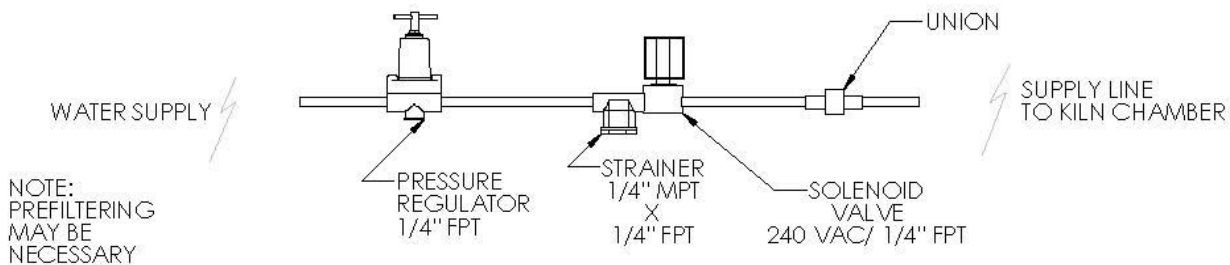

NOTE:  
PREFILTERING  
MAY BE  
NECESSARY

LOCATE SUPPLY LINE IN A CONVENIENT LOCATION

ELECTICAL CONNECTIONS:  
WIRE THE SOLENOID VALVE BACK TO NYLE ELECTRICAL  
PANEL AND CONNECT TO TB1 **16** AND **N**

## Kiln Store

---

Nyle Systems likes to be there for our clients whether they have just bought a new kiln or if they have owned a Nyle kiln for years. It is because of this that we try to make replacement parts easily accessible right Online in our Kiln Store.

From The Kiln Store you can find many parts, equipment and accessories for both conventional kilns and DH kilns. Anything and everything you need to keep your Nyle Kiln running for years to come. We even sell parts supplies that will fit Non-Nyle kilns if you need them.

At The Kiln Store you can expect to find everything you need including:

- Accessory Kits
- Controls and Control Accessories
- Additional Heaters and Fans
- Sample Testing Supplies and Charts
- Replacement Meters, Probes and Sensors
- Replacement Belts, Filters and Parts

So when you need a part for your kiln you don't have to look any further than [www.nyle.com](http://www.nyle.com) to find exactly what you need.

If you ever need assistance don't forget Nyle's star service team is always available to help you whether its finding the right replacement part or purchasing additional accessories for upgrades.

Contact your Nyle Sales or Service Representative for more information. You can reach a Nyle Service Professional by:

Calling us directly at (800)777-6953 X 212 or by sending us an email at [service@nyle.com](mailto:service@nyle.com)

## Warranty

---

LIMITED WARRANTY: The equipment supplied by Nyle Dry Kilns is warranted to be free from defects in workmanship and materials for a period of one year from the date of the original installation under normal use and maintenance, or 15 months from the date of delivery, whichever comes first. A new or re-manufactured part will be supplied by Nyle Dry Kilns if the defective part is first returned to Nyle Dry Kilns for inspection. The replacement part assumes the unused portion of the warranty. The warranty does not include labor or other costs incurred for diagnosis, repairing or removing, installing or shipping the defective or replacement part(s). Nyle Dry Kilns makes no warranty as to the fitness of the equipment for a particular use and shall not be liable for any direct, indirect or consequential damages in conjunction with this contract and/or the use of its equipment. Buyer agrees to indemnify and save harmless Nyle Dry Kilns from any claims or demands against Nyle Dry Kilns for injuries or damages to the third parties resulting from buyer's use or ownership of the equipment. No other warranties, expressed or implied, will be honored unless in writing by an authorized officer of Nyle Dry Kilns.

Model \_\_\_\_\_

Serial Number \_\_\_\_\_

Date Purchased \_\_\_\_\_

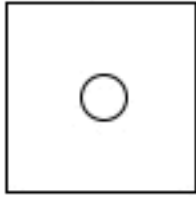

Wet Bulb Sensor Bracket



Wet Bulb Bottle

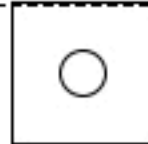

Dry Bulb Sensor Bracket

Fold Line



12 Stevens Road  
Brewer, Maine 04412  
Tel: 1-207-989-4335 Fax: 1-207-989-1101  
Email: info@nyle.com  
1-800-777-6953

TITLE	WET BULB / DRY BULB INSTALLATION TEMPLATE		
CUSTOMER			
DWG FILE NAME		REV	
CHECKED		SCALE	SHEET 1

**PROPRIETARY AND CONFIDENTIAL**  
THE INFORMATION CONTAINED IN  
THIS DRAWING IS THE SOLE PROPERTY OF  
NYLE SYSTEMS. ANY REPRODUCTION IN  
PART OR AS A WHOLE WITHOUT THE  
WRITTEN PERMISSION OF NYLE SYSTEMS IS  
PROHIBITED.

DRAWN

CHECKED

















# Unit Data Stickers

		
MANUFACTURED BY Nyle Systems LLC 12 Stevens Rd Brewer, ME 04412		
TEL: 1-800-777-6953 INTL: 1-207-989-4335 WEB: www.nyle.com EMAIL: info@nyle.com		
MODEL: <b>L200S</b>	SERIAL:	MFG DATE:
VOLTAGE: <b>240/1/50</b>	MAX FULL LOAD AMPS: <b>39A</b>	
HIGH SIDE TEST PRESSURE: <b>400 PSIG (2.758 MPa)</b>		
LOW SIDE TEST PRESSURE: <b>150 PSIG (1.034 MPa)</b>		
REFRIGERANT CHARGE APPROXIMATELY: <b>60 OZ (1700g) OF R-134A</b>		
TYPE 1 ENCLOSURE (For Indoor Use Only)		
<b>WARNING:</b> CAPACITIVE VOLTAGE ABOVE 50V MAY REMAIN FOR <b>300 SECONDS</b> AFTER POWER IS DISCONNECTED.		
<b>WARNING:</b> MANUFACTURER'S INSTRUCTIONS FOR SELECTING CURRENT ELEMENTS AND SETTING THE INTERRUPTERS MUST BE FOLLOWED.		
<b>AVERTISSEMENT:</b> SUIVRE LES INSTRUCTIONS DU FABRICANT POUR LA SÉLECTION DES ÉLÉMENTS PORTEURS DE COURANT ET RÉGLAGE DES INTERRUPTEURS.		
<b>WARNING:</b> IF THE INTERRUPTER HAS TRIPPED, CURRENT-CARRYING COMPONENTS OF THE CONTROLLER SHOULD BE EXAMINED AND REPLACED IF DAMAGED.		
<b>AVERTISSEMENT:</b> SI L'INTERRUPTEUR S'EST DÉCLENCHÉ, EXAMINER LES PIÈCES SOUS TENSION DU CONTRÔLEUR ET AU BESOIN, LES REMPLACER.		
<b>CAUTION:</b> DISCONNECT MEANS TO BE PROVIDED BY OTHERS IN ACCORDANCE WITH ELECTRICAL CODE AND LOCAL CODES.		
<b>ATTENTION:</b> DÉCONNECTER UN MOYEN À FOURNIR PAR D'AUTRES CONFORMÉMENT AU CODE ÉLECTRIQUE ET AUX CODES LOCAUX.		
<b>CAUTION:</b> DO NOT CHARGE TO FULL SIGHT GLASS CONSULT MANUAL OR CALL NYLE SYSTEMS.		
<b>CAUTION:</b> IF THE POWER CORD IS DAMAGED THE CORD MUST BE REPLACED BEFORE OPERATING.		
		
MANUFACTURED IN THE USA		

		
MANUFACTURED BY Nyle Systems LLC 12 Stevens Rd Brewer, ME 04412		
TEL: 1-800-777-6953 INTL: 1-207-989-4335 WEB: www.nyle.com EMAIL: info@nyle.com		
MODEL: <b>L200M</b>	SERIAL:	MFG DATE:
VOLTAGE: <b>240/1/50</b>	MAX FULL LOAD AMPS: <b>39A</b>	
HIGH SIDE TEST PRESSURE: <b>400 PSIG (2.758 MPa)</b>		
LOW SIDE TEST PRESSURE: <b>150 PSIG (1.034 MPa)</b>		
REFRIGERANT CHARGE APPROXIMATELY: <b>60 OZ (1700g) OF R-134A</b>		
TYPE 1 ENCLOSURE (For Indoor Use Only)		
<b>WARNING:</b> CAPACITIVE VOLTAGE ABOVE 50V MAY REMAIN FOR <b>300 SECONDS</b> AFTER POWER IS DISCONNECTED.		
<b>WARNING:</b> MANUFACTURER'S INSTRUCTIONS FOR SELECTING CURRENT ELEMENTS AND SETTING THE INTERRUPTERS MUST BE FOLLOWED.		
<b>AVERTISSEMENT:</b> SUIVRE LES INSTRUCTIONS DU FABRICANT POUR LA SÉLECTION DES ÉLÉMENTS PORTEURS DE COURANT ET RÉGLAGE DES INTERRUPTEURS.		
<b>WARNING:</b> IF THE INTERRUPTER HAS TRIPPED, CURRENT-CARRYING COMPONENTS OF THE CONTROLLER SHOULD BE EXAMINED AND REPLACED IF DAMAGED.		
<b>AVERTISSEMENT:</b> SI L'INTERRUPTEUR S'EST DÉCLENCHÉ, EXAMINER LES PIÈCES SOUS TENSION DU CONTRÔLEUR ET AU BESOIN, LES REMPLACER.		
<b>CAUTION:</b> DISCONNECT MEANS TO BE PROVIDED BY OTHERS IN ACCORDANCE WITH ELECTRICAL CODE AND LOCAL CODES.		
<b>ATTENTION:</b> DÉCONNECTER UN MOYEN À FOURNIR PAR D'AUTRES CONFORMÉMENT AU CODE ÉLECTRIQUE ET AUX CODES LOCAUX.		
<b>CAUTION:</b> DO NOT CHARGE TO FULL SIGHT GLASS CONSULT MANUAL OR CALL NYLE SYSTEMS.		
<b>CAUTION:</b> IF THE POWER CORD IS DAMAGED THE CORD MUST BE REPLACED BEFORE OPERATING.		
		
MANUFACTURED IN THE USA		

		
MANUFACTURED BY Nyle Systems LLC 12 Stevens Rd Brewer, ME 04412		
TEL: 1-800-777-6953 INTL: 1-207-989-4335 WEB: www.nyle.com EMAIL: info@nyle.com		
MODEL: <b>L200S</b>	SERIAL:	MFG DATE:
VOLTAGE: <b>240/1/60</b>	MAX FULL LOAD AMPS: <b>30A</b>	MIN CAPACITY: <b>45A</b>
<b>50 AMP NO TIME DELAY FUSE OR CIRCUIT BREAKER SHALL BE USED</b>		
HIGH SIDE TEST PRESSURE: <b>400 PSIG (2.758 MPa)</b>		
LOW SIDE TEST PRESSURE: <b>150 PSIG (1.034 MPa)</b>		
REFRIGERANT CHARGE APPROXIMATELY: <b>60 OZ (1700g) OF R-134A</b>		
TYPE 1 ENCLOSURE (For Indoor Use Only)		
<b>WARNING:</b> CAPACITIVE VOLTAGE ABOVE 50V MAY REMAIN FOR <b>300 SECONDS</b> AFTER POWER IS DISCONNECTED.		
<b>WARNING:</b> MANUFACTURER'S INSTRUCTIONS FOR SELECTING CURRENT ELEMENTS AND SETTING THE INTERRUPTERS MUST BE FOLLOWED.		
<b>AVERTISSEMENT:</b> SUIVRE LES INSTRUCTIONS DU FABRICANT POUR LA SÉLECTION DES ÉLÉMENTS PORTEURS DE COURANT ET RÉGLAGE DES INTERRUPTEURS.		
<b>WARNING:</b> IF THE INTERRUPTER HAS TRIPPED, CURRENT-CARRYING COMPONENTS OF THE CONTROLLER SHOULD BE EXAMINED AND REPLACED IF DAMAGED.		
<b>AVERTISSEMENT:</b> SI L'INTERRUPTEUR S'EST DÉCLENCHÉ, EXAMINER LES PIÈCES SOUS TENSION DU CONTRÔLEUR ET AU BESOIN, LES REMPLACER.		
<b>CAUTION:</b> DISCONNECT MEANS TO BE PROVIDED BY OTHERS IN ACCORDANCE WITH ELECTRICAL CODE AND LOCAL CODES.		
<b>ATTENTION:</b> DÉCONNECTER UN MOYEN À FOURNIR PAR D'AUTRES CONFORMÉMENT AU CODE ÉLECTRIQUE ET AUX CODES LOCAUX.		
<b>CAUTION:</b> DO NOT CHARGE TO FULL SIGHT GLASS CONSULT MANUAL OR CALL NYLE SYSTEMS.		
<b>CAUTION:</b> IF THE POWER CORD IS DAMAGED THE CORD MUST BE REPLACED BEFORE OPERATING.		
		
MANUFACTURED IN THE USA		

		
MANUFACTURED BY Nyle Systems LLC 12 Stevens Rd Brewer, ME 04412		
TEL: 1-800-777-6953 INTL: 1-207-989-4335 WEB: www.nyle.com EMAIL: info@nyle.com		
MODEL: <b>L200M</b>	SERIAL:	MFG DATE:
VOLTAGE: <b>240/1/60</b>	MAX FULL LOAD AMPS: <b>30A</b>	MIN CAPACITY: <b>45A</b>
<b>50 AMP NO TIME DELAY FUSE OR CIRCUIT BREAKER SHALL BE USED</b>		
HIGH SIDE TEST PRESSURE: <b>400 PSIG (2.758 MPa)</b>		
LOW SIDE TEST PRESSURE: <b>150 PSIG (1.034 MPa)</b>		
REFRIGERANT CHARGE APPROXIMATELY: <b>60 OZ (1700g) OF R-134A</b>		
TYPE 1 ENCLOSURE (For Indoor Use Only)		
<b>WARNING:</b> CAPACITIVE VOLTAGE ABOVE 50V MAY REMAIN FOR <b>300 SECONDS</b> AFTER POWER IS DISCONNECTED.		
<b>WARNING:</b> MANUFACTURER'S INSTRUCTIONS FOR SELECTING CURRENT ELEMENTS AND SETTING THE INTERRUPTERS MUST BE FOLLOWED.		
<b>AVERTISSEMENT:</b> SUIVRE LES INSTRUCTIONS DU FABRICANT POUR LA SÉLECTION DES ÉLÉMENTS PORTEURS DE COURANT ET RÉGLAGE DES INTERRUPTEURS.		
<b>WARNING:</b> IF THE INTERRUPTER HAS TRIPPED, CURRENT-CARRYING COMPONENTS OF THE CONTROLLER SHOULD BE EXAMINED AND REPLACED IF DAMAGED.		
<b>AVERTISSEMENT:</b> SI L'INTERRUPTEUR S'EST DÉCLENCHÉ, EXAMINER LES PIÈCES SOUS TENSION DU CONTRÔLEUR ET AU BESOIN, LES REMPLACER.		
<b>CAUTION:</b> DISCONNECT MEANS TO BE PROVIDED BY OTHERS IN ACCORDANCE WITH ELECTRICAL CODE AND LOCAL CODES.		
<b>ATTENTION:</b> DÉCONNECTER UN MOYEN À FOURNIR PAR D'AUTRES CONFORMÉMENT AU CODE ÉLECTRIQUE ET AUX CODES LOCAUX.		
<b>CAUTION:</b> DO NOT CHARGE TO FULL SIGHT GLASS CONSULT MANUAL OR CALL NYLE SYSTEMS.		
<b>CAUTION:</b> IF THE POWER CORD IS DAMAGED THE CORD MUST BE REPLACED BEFORE OPERATING.		
		
MANUFACTURED IN THE USA		

**nyle**  
Dry Kilns



*Check out our complete line of videos providing tips on kiln drying and preventative maintenance*

**nyle**  
**KILNIQ**



**nyle**  
**KILNTECH**