

nyle
Dry Kilns

User Manual

PHT / FHT Series



© 2020 Nyle Dry Kilns
PHT/FHT Manual V4.1



www.nyle.com - kilnsales@nyle.com - (800) 777-6953

Table of Contents

Safety Guidelines	1
Precautions	1
Electrical Grounding.....	1
Screen Outlines	3
Kiln Dry Mode.....	3
Heat Treat Mode.....	4
Quick Start up Guide	5
Getting Started.....	5
General Control Information	7
PLC Modules.....	7
Touch Screen Interface.....	7
Web Server and Remote Access.....	7
Root Screen.....	7
Start Up Screen.....	7
Additional Setup Screen	7
Support Screen.....	8
Trend Screen.....	8
Alarm Screen	8
System Information	8
USDA Requirements.....	8
Sequence of Operations	9
System Cycle.....	9
Heat Logic	9
Vent Logic.....	9
Data Logs.....	9
Data Logging	9
Starting a Data Log	9
Retrieving a Data Log.....	9
Remote Access	9
Setting up Remote Access on HMI	9
Setting up Remote Access with VNC Viewer.....	10
Control Wiring	11
Output Wiring	13
RTD Wiring	14
Typical Vent Circuits	15
Service Log	16

⚠️ WARNING Read through entire manual before installing, operating, or servicing this unit. Failure to follow any steps or guidelines could result in personal injury, death, destruction of property or may cause the unit to become inoperable. **This manual must be kept with the unit at all times.**

Safety Guidelines

Precautions

Do not operate if the unit or any of its parts:

- Have been exposed to fire.
- Have been submerged in or exposed to excessive water.
- Has significant interior or exterior damage.

If any of the above are suspected make sure to have your unit serviced by a qualified professional before continuing operation.

Electrical Grounding

The unit must be grounded.

Failure to ground the unit will result in unreliable performance or an inoperative unit. You can ground the unit by connecting the unit to a grounded metal, permanent wiring system. Make sure the unit is in accordance with national and local electrical codes. If you don't know the building codes in your area or need more information, please contact your municipal office.

⚠️ WARNING	Refrigerant!
<ul style="list-style-type: none">• Unit contains R-416a / FR12 refrigerant under high pressure. Refrigerant must be recovered to relieve pressure before servicing.• DO NOT use unapproved refrigerants, substitutes or additives.• Failure to abide by these guidelines can result in death, injury and property damages.• Contact Nyle's service department for more information on refrigerant options.	

⚠️ WARNING	
High Temperatures!	
<ul style="list-style-type: none">• Kiln chamber can reach internal temperatures of over 90°F. working in these temperatures can cause heat stroke and minor burns.• Pregnant women, children, the elderly and those with significant health issues are at higher risk of heat stroke and must be supervised in high temperatures.• Kiln operators should check for temperature and take proper safety precautions before entering the kiln chamber.	

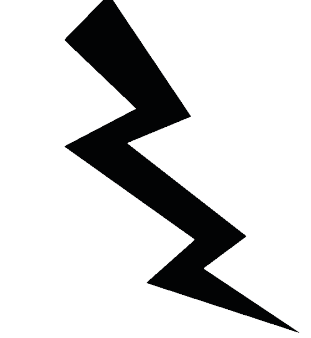
⚠️ WARNING	
Electrical Shock!	
<ul style="list-style-type: none">• Turn off power to unit before service.• Make sure wires are labeled before disconnecting.• Test unit after reconnecting wires.• Failure to do the above could result in death or injury.	

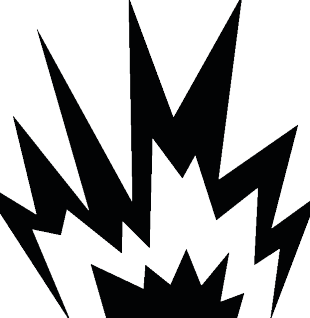
⚠️ WARNING	
Explosion Hazard!	
<ul style="list-style-type: none">• DO NOT purge or pressurize this system with oxygen to test for leakage. Using oxygen may cause explosive reaction.	

Screen Outlines

Kiln Dry Screens

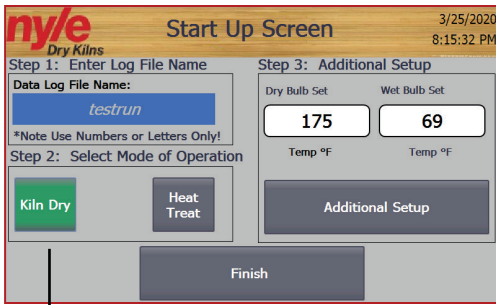

Kiln Dry Start up Screen

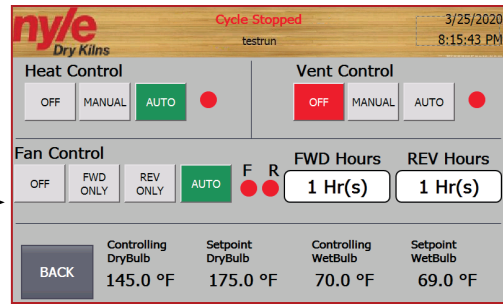

Kiln Dry Additional Setup Screen

Kiln Dry Root Screen

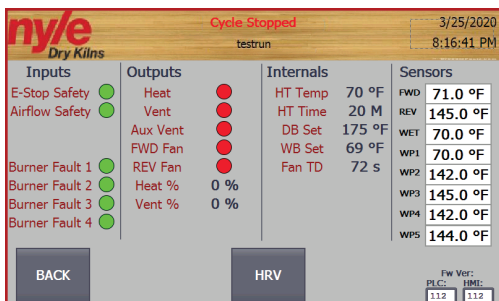
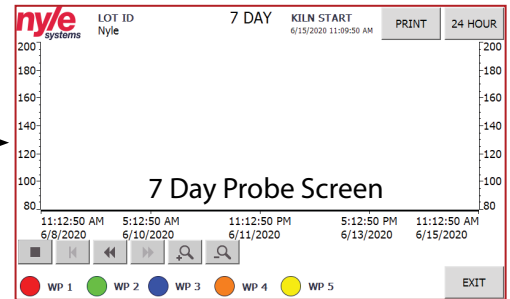
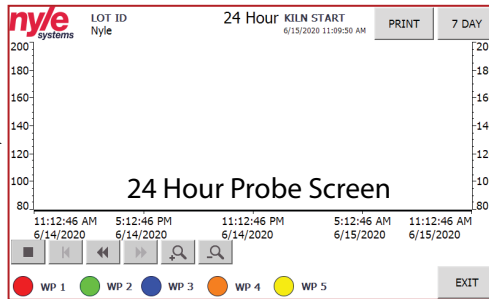
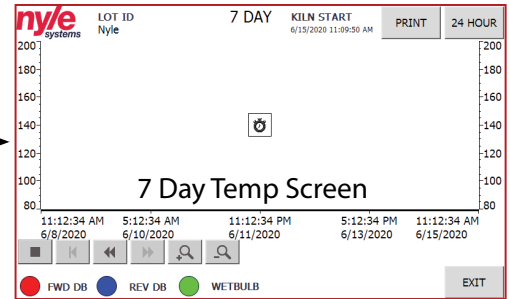
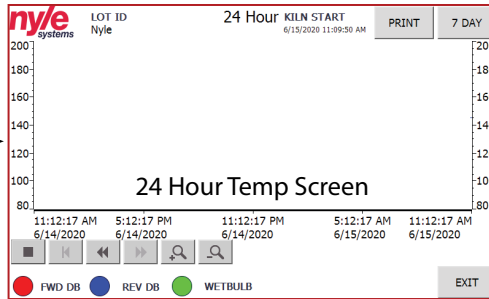
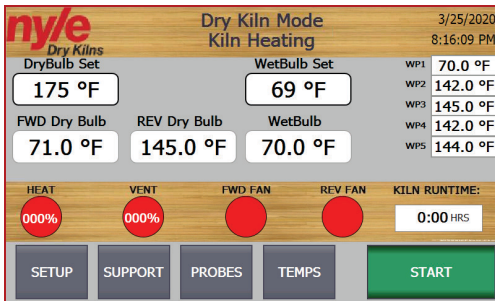

Support Screen

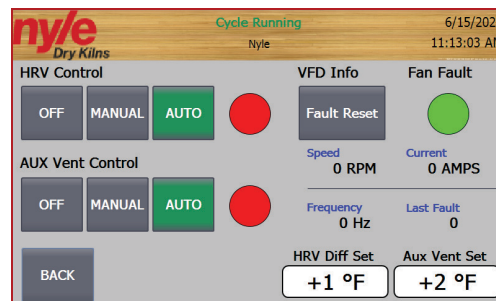

HRV Screen (if jumper is attached)

Heat Treat Screens

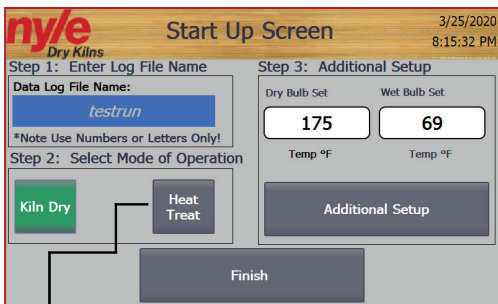

Heat Treat Start up Screen

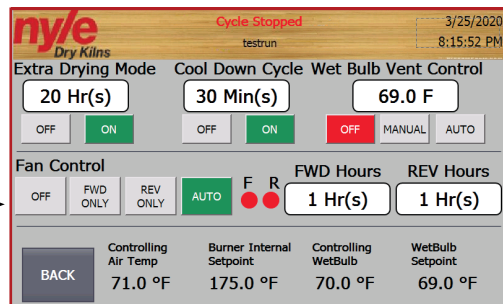

Heat Treat Additional Setup Screen

Heat Treat Root Screen

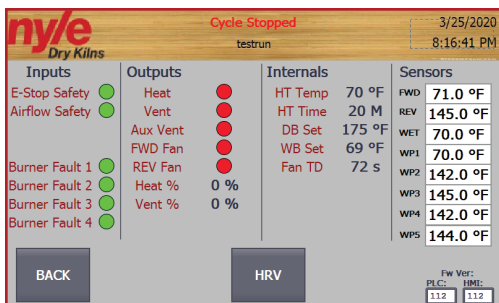
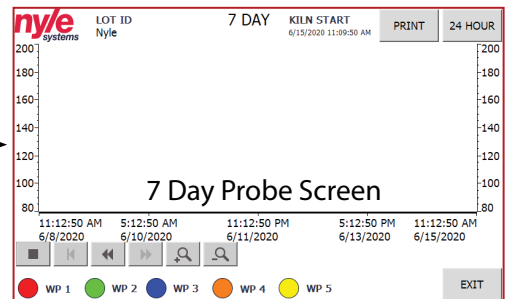
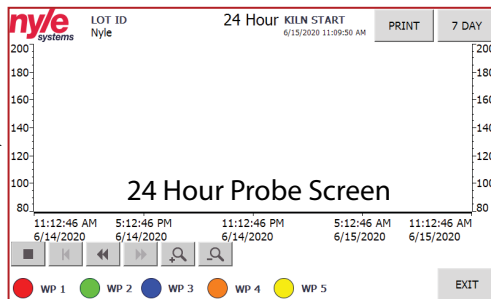
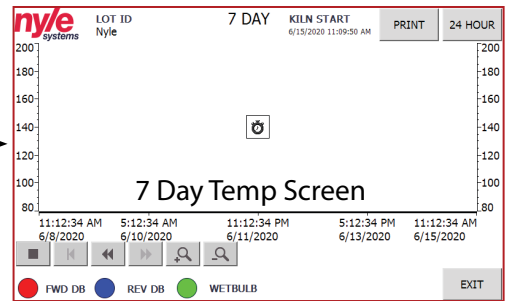
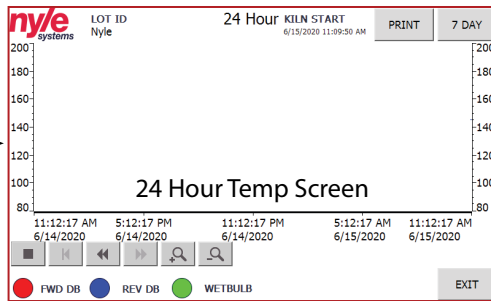
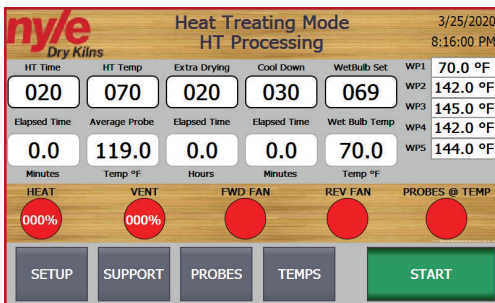

Support Screen

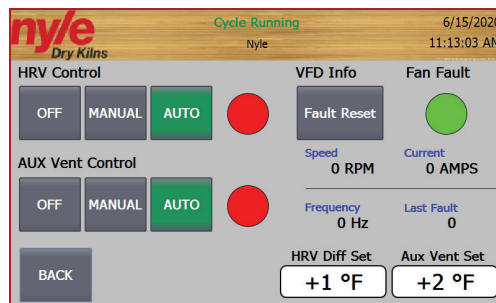

HRV Screen (if jumper is attached)

Quick Start Up Guide

Getting Started

Your kiln control system includes screens for startup, configuration, and monitoring.

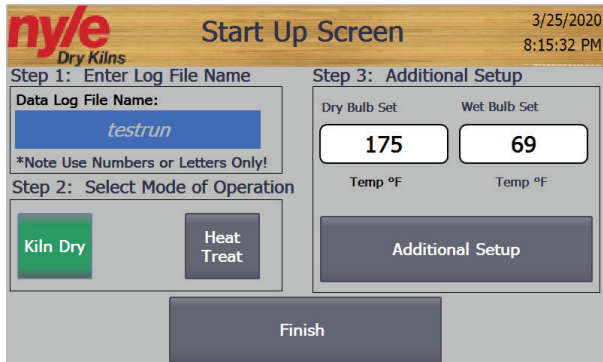

Start up Screen

The Start up Screen is the default screen displayed when the kiln is powered on. This screen is used prior to starting the kiln for initial configuration. Nyle Presets the default setting for the purchased application. Check with local and state agencies to verify the default settings meet or exceed the requirement for heat treating in your area.

Follow the steps below to get your kiln started.

1. Enter Log File Name

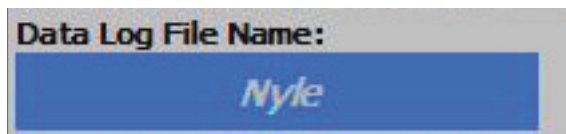

The default log file name is: Nyle. This is provided to ensure logs are always captured during initial start up of the kiln. This should be set to a unique value for any kiln cycle run for certification and data archival purposes. When entering the name be sure to only use numbers and letters, other keyboards values will fault the log system.

2. Select the Mode of Operation



The button will turn green when selected. The input values on the right hand side will changes as well to match the selected mode.

Kiln Dry Mode: Configures the kiln to dry using only the Dry and Wet bulb set points.

Heat Treat Mode: Configured the kiln to heat treat using wood probe temperature and time once the probe set-point is reached.

3. Additional Setup

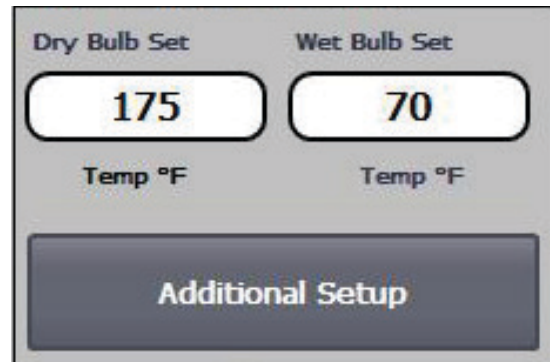

Depending on the mode previously set, enter set-points to change the defaults as required. The Additional Setup button will provide additional configuration during kiln mode for heat, vents, and fan direction if equipped. When Heat Treat Mode is set it will allow the user to set extra drying time, cool down time to the cycle, as well as the wet bulb set for vent operation if required.

4. I. Press the finish button and you will move to the Home Status Screen of the selected mode.
- II. Verify the required settings for the cycle are set. If correct proceed, otherwise press the setup button to go back to the start up screen.
- III. Press the start button
5. Monitor to verify the cycle is treating or drying as intended using the Home Screen, Trends, and the Data Logs. If using Kiln Drying Mode the user will need to manually end the cycle as needed. Heat Treating Mode automatically advances to extra dry and cooling modes if enabled and ends the cycle once conditions are reached.

General Control Information

PLC Modules

The advanced control system uses a PLC controller with a built-in Ethernet switch, 24VDC power supply, and a RTD based temperature module. The HMI contains an SD data card and is used to store data logs for each cycle. The data logs are accessible via a LAN connection.

Touch Screen Interface

The advanced control system uses a color touch screen as a main interface for operating the kiln chamber. The touch screen is capable of performing kiln operations including; data logs, reading trends, and monitoring status.

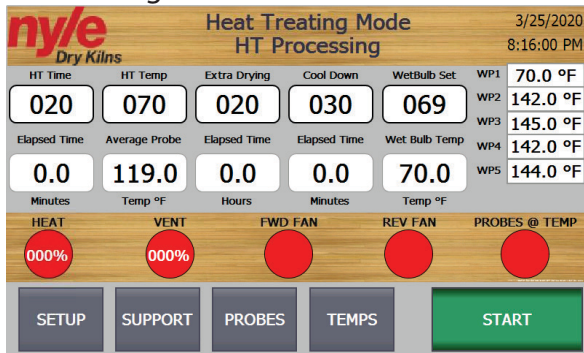

Main Screen

Web Server and Remote Access

The advanced control offers a VNC server control with full control capabilities enabled. Kiln operators can use the built in VNC server to monitor all kiln conditions on any kiln that is connected to the LAN. This VNC server can, with very little effort, be accessed via the web on cell phones, tablets and remote computers.

Off-site Access is achieved using site provided VPN. Each kiln is accessible via its IP address, which is typically assigned in the factory. For information on changing the default IP address, please call Nyle at (800) 777-6953

Example kiln IP addresses are:

For the PLC :

192.168.1.70

For the interface:

192.168.1.71

Root Screen

The **Root** Screen is the home status screen for the mode you choose. From the Root Screen you can use the Root screen to access the Setup, Support, Probe, and Temperature screens. The Root screen displays current temperatures/conditions inside the kiln and cycle status. The Root screen is also the only screen capable of starting or stopping the kiln cycle.

Start Up Screen

The **Start Up** Screen is used for the setup of the cycle. From the Start up screen you can select your drying mode, create the data log file, as well as set up the general parameters for the cycle.

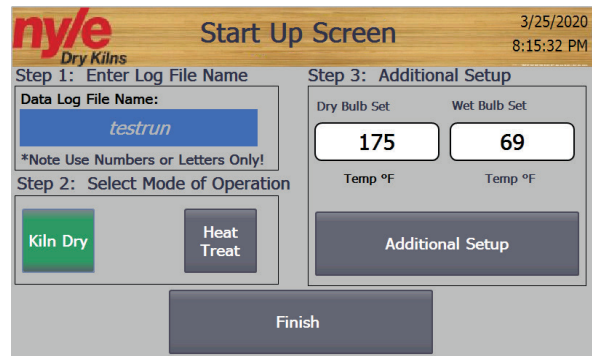

Start Up Screen

Additional Setup Screen

The **Additional Setup** Screen is where users go to setup their drying cycle. Through the Additional Setup Screen a kiln operator can control the Heat, Fan, and Vent controls. Extra Drying and Cool Down Cycle modes can be controlled from this screen if enabled. The controlling dry bulb, dry bulb set-point, controlling wet bulb and wet bulb set-point are also displayed on this page at the bottom. To go back to the home page, click the home button.

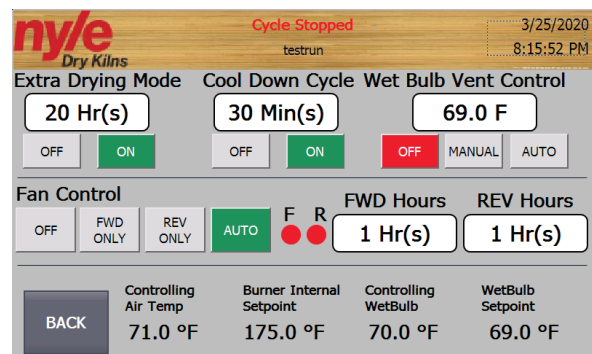

Additional Setup Screen

Support Screen

The **Support** screen is a helpful interface for viewing what is happening with your kiln. On this screen, displayed is each wood probes current temperature and the dry bulb and wet bulb temperature. To the left is the Emergency stop safety and Airflow safety which is displayed by either a red light meaning it is off or a green light meaning it is on. Next to those are heat call, vent call, and blower call. These are also displayed by either a red light meaning it is off or a green light meaning it is on.

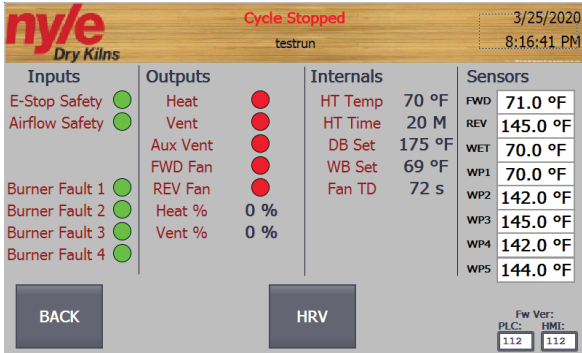

Support Screen

Trend Screen

The **Trend** screens are the Probes and Temp Screens accessed through the Root screen. In these screens, the user can see real time data logging. This data logs the dry bulb, wet bulb, and each wood probe for 24 hours or 7 days. The user can print the data log by simply pressing the print button after the printer is configured to work with the HMI.

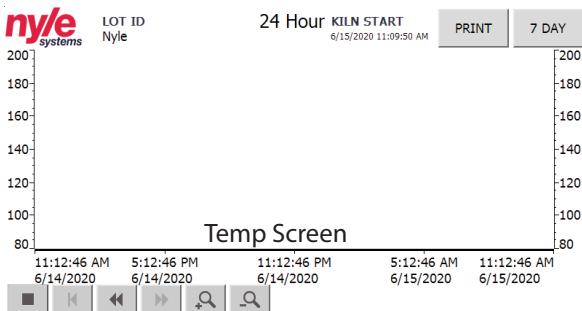

Temp Screen

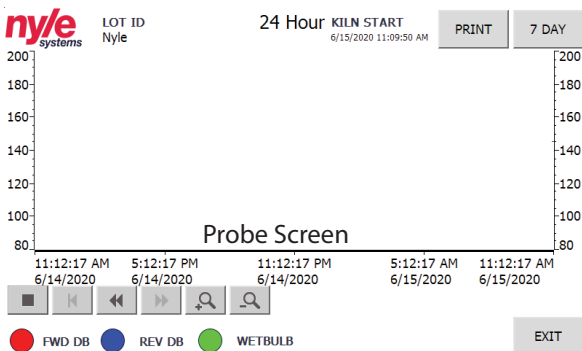

Probe Screen

Alarm Screen

When the kiln encounters a fault it will trigger an alarm. The **alarm** screen lists out all of the faults and their status. These are also displayed by either a red light meaning the fault had been triggered or a green light meaning it has not been triggered.

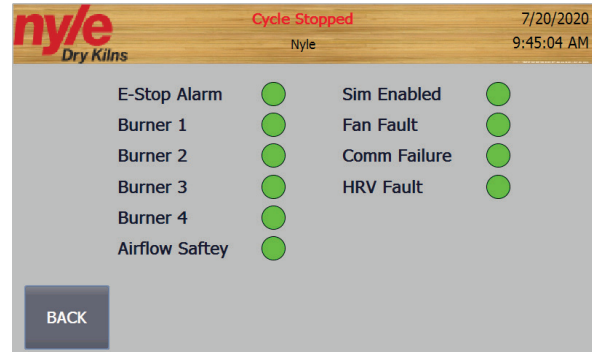

Alarm Screen

Alarm Faults

Fan Fault	Fan Overloaded
	Contractor Signal
Blower Overload	Blower Overload
	Contractor Signal
Burner Fault 1	Burner Malfunction
	Check Heater Control 1
Burner Fault 2	Burner Malfunction
	Check Heater Control 2
Burner Fault 3	Burner Malfunction
	Check Heater Control 3
Burner Fault 4	Burner Malfunction
	Check Heater Control 4

System Information

USDA Requirements

See Below for Typical USDA Requirements for Drying

State Requirements may differ

Pallet Heat Treating

Internal Probe Temperature of 140°F for 40 Minutes

Firewood Heat Treating

Internal Probe Temperature of 160°F for 75 Minutes

Control Operations

System Cycle

1. If the probes meet the treating temperature, it will start counting down.
2. When the sterilization timer reaches set time the kiln will advance to the next mode if enabled.
3. If Vent After Treat is true, vents will open after the sterilization timer reaches set time.

Heat

If chamber temperature gets lower than the chamber temperature set point, the Chamber will heat up until the chamber temperature is higher than the chamber temperature set point.

Vent

1. If chamber temperature gets 10 degrees higher than the set point, the vents open until the chamber temperature is equal to the chamber temperature set point.
2. Optionally, if activated in the configuration control screen, vents will open if wet bulb goes higher than the wet bulb set point.

Data Logs

1. In cycle records air temperature, wood probes, treating temperature set point, and chamber temperature.
2. Records every minute
3. Stores to SD Card

Data Logging

Starting a Data Log

Logging data with the control is simple. The control is capable of storing up to 25 complete cycle logs in most cases. The HMI will automatically save data logs every time the unit is in cycle.

Retrieving a Data Log

All data logs are stored on the HMI flash drive as a .CSV data log file. To obtain the data logs the kiln operator may either log into the HMI via the web interface or pull the SD card and copy the files over to a computer. Reboot required when reinstalled.

To retrieve the data through the web interface, enter the IP address of the connected HMI into a web browser connected to the same local area network. Click "ENTER" to proceed into the default web interface. Login using supplied login from Nyle Systems. Click on "DATA LOGS" to view, download, and clear the data logs stored on the HMI. Each log file will have the same name as the LOG FILE NAME that was entered when starting the kiln cycle.

Remote Access

Setting up Remote Access on HMI

First, the user needs to make sure the unit is on the same network as the device or devices that the user wants to use the remote access feature with. To get the unit Online, run an Ethernet cable that is plugged into your network to the unit's PLC. Plug the Ethernet cable into the bottom left corner of the PLC. There will be one Ethernet cable already plugged in. Plug the Ethernet cable in next to the one already plugged in, this will connect the unit to the LAN. The HMI screen will be configured to use remote access when shipped. However, if you need to setup remote access on the HMI screen, follow the steps below.

1. Once you have a program downloaded to the HMI and it is ready to setup, go into the control menu by pressing the top right corner of the screen on the clock.

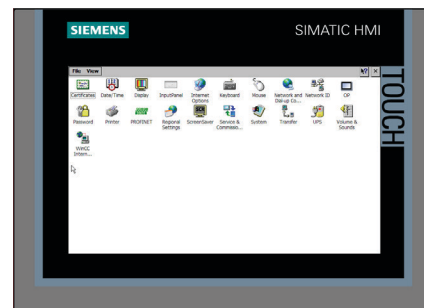

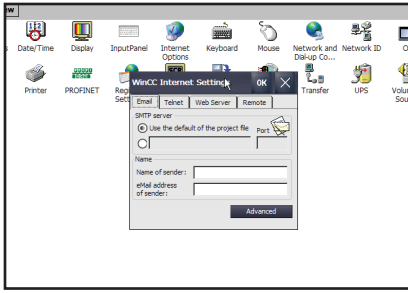

2. When you are in the control menu, click on WinCC. Choose remote and change the settings.

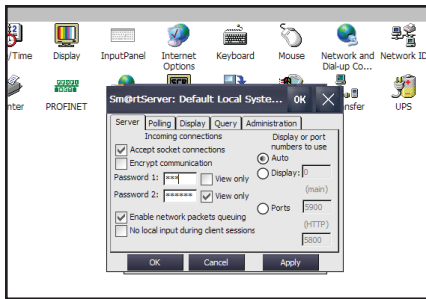
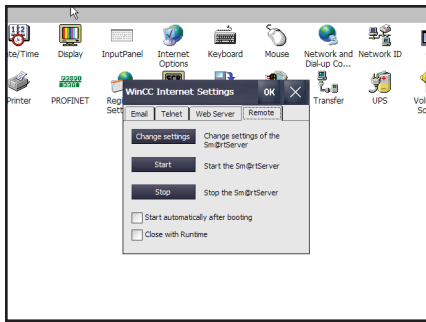

3. Choose the password one box and set the password to 100. Apply and choose yes.
4. Check the box that reads start automatically.
5. Press the start button and press OK. You will now be able to remote access to this HMI

Setting up Remote Access with VNC Viewer

To remote into the HMI screen from another device the user will need to install a program called VNC Viewer. The link for this program is posted below.

<https://www.realvnc.com/en/connect/download/viewer/>

After VNC Viewer is installed, the user will need to setup a connection to the HMI screen in the search bar at the top of the window in VNC Viewer. The search bar will read Enter a VNC Search Address or search. This is where the user will enter the IP address and press enter.

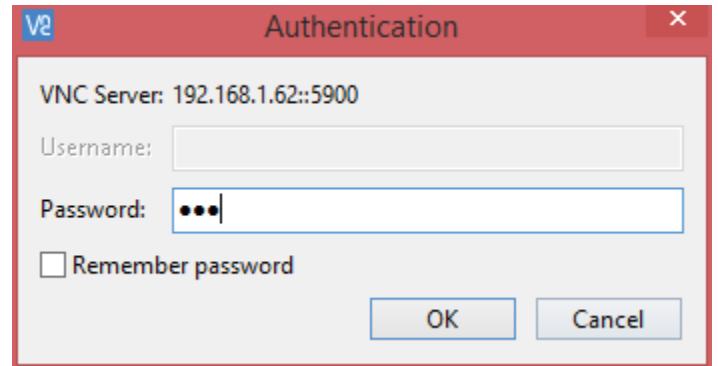
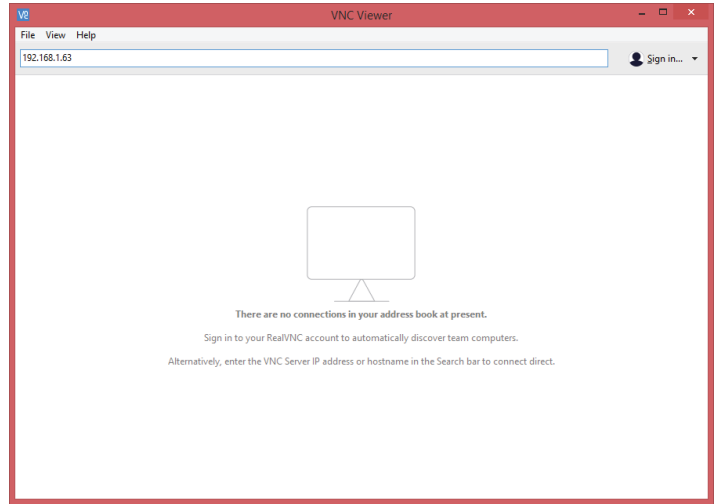

Type in 100 and then press OK or enter. This will bring up the same screen that is displayed on the HMI screen and the user will be able to monitor or change values as the user would be able to on the HMI screen.

Control Wiring

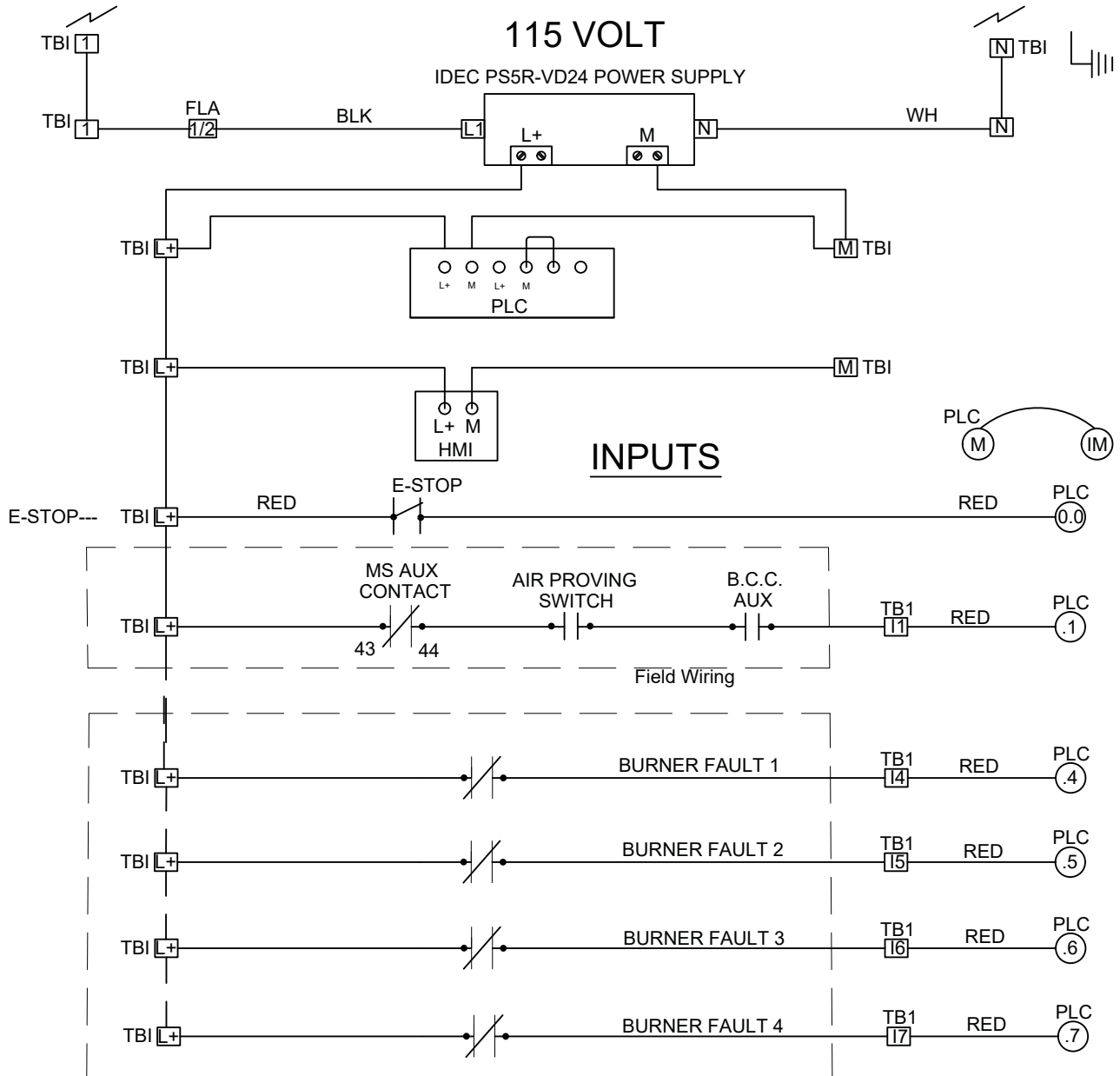

MS AUX CONTACT - MOTOR STARTER AUX CONTACT
 B.C.C. AUX - BLOWER CONTACT COIL AUX CONTACT
 H.C.C/H.S - HEAT CONTACTOR COIL / HEAT SIGNAL
 F.F.C.C. - FAN FORWARD CONTACTOR COIL
 F.R.C.C. - FAN REVERSE CONTACTOR COIL
 B.C.C. - BLOWE CONTACTOR COIL
 V.R.C - VENT RELAY COIL

 <small>12 Stevens Road Brewer, Maine 04412 Tel: 1-207-858-4235; 985-1951; 1-800-777-6953 Fax: 1-207-858-1101; Email: info@nyle.com</small>	TITLE INPUT CONTROL WIRING	
	PART NUMBER NSC PHT	
DRAWN BY NR	DWG FILE NAME NSC PHT	REV 1.2
CHECKED	SCALE NTS	SHEET 1 OF 4

TB1
1
1
N
N
--
L+
L+
L+
M
M
M
W
R
B
I0
I1
I2
I3
I4
I5
I6
I7
I.5b
--
--
--
--

TB2
AQ0
AQ1

TB3
5
4
L+
M
--
--
--

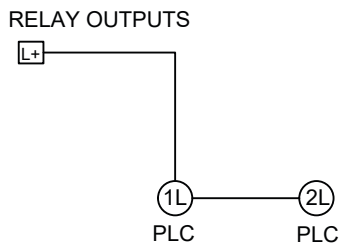

SLICE RELAYS

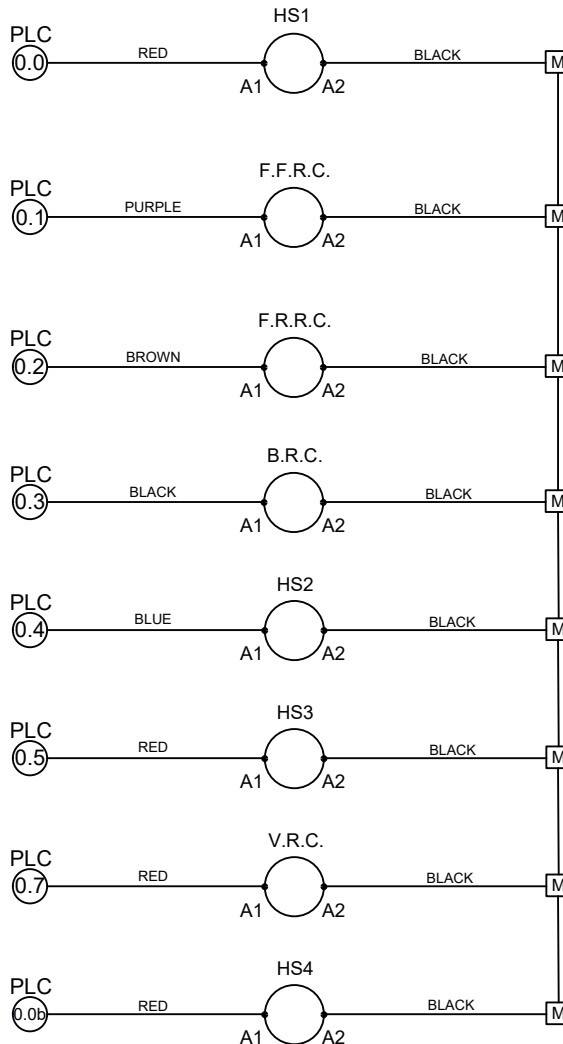

4-20 mA ANALOG OPTIONS VENT AND HEAT OPTIONS

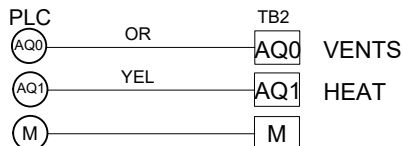



500Ω RESISTORS CAN BE INSTALLED
FOR 2-10V ACTUATORS

 <small>12 Stevens Road Brown, Maine 04412 Tel: 1-207-569-4335 ext: 1-800-777-6963 Fax: 1-207-695-1191 Email: info@nye.com</small>	TITLE OUTPUT CONTROL WIRING	
	PART NUMBER NSC PHT	
DRAWN BY NR	DWG FILE NAME NSC PHT	REV 1.2
CHECKED	SCALE NTS	SHEET 2 OF 4

RTD Wiring

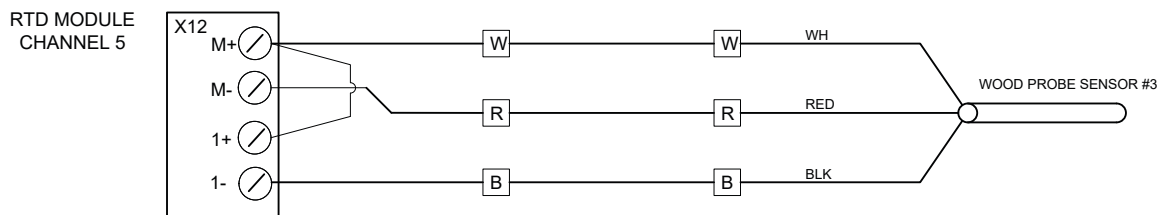
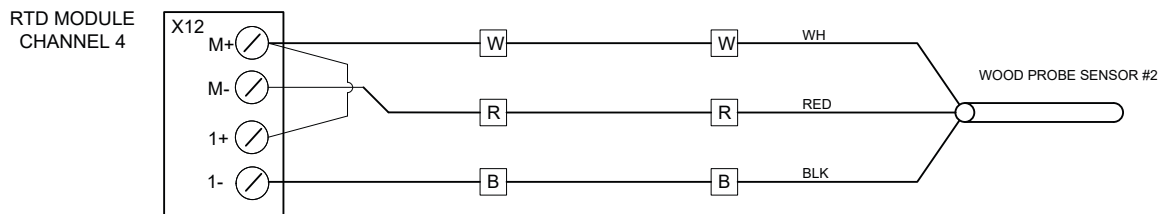
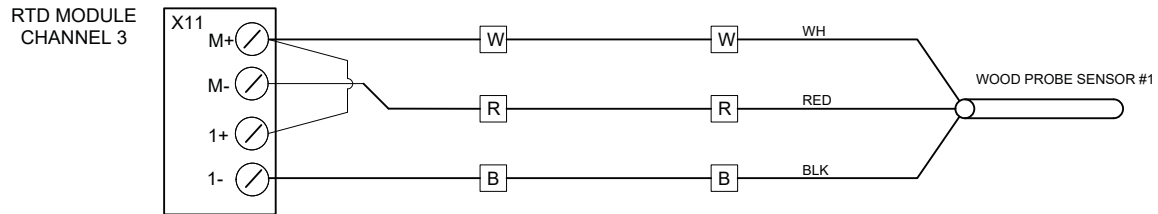
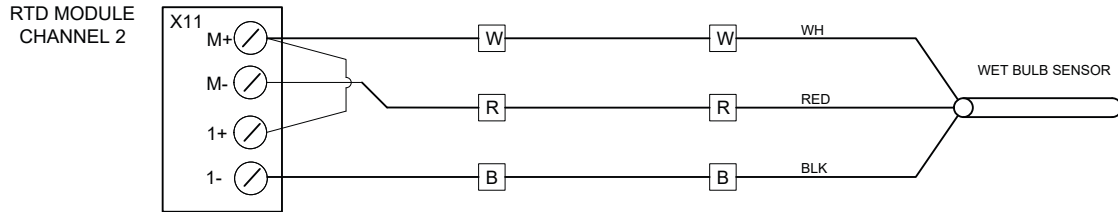
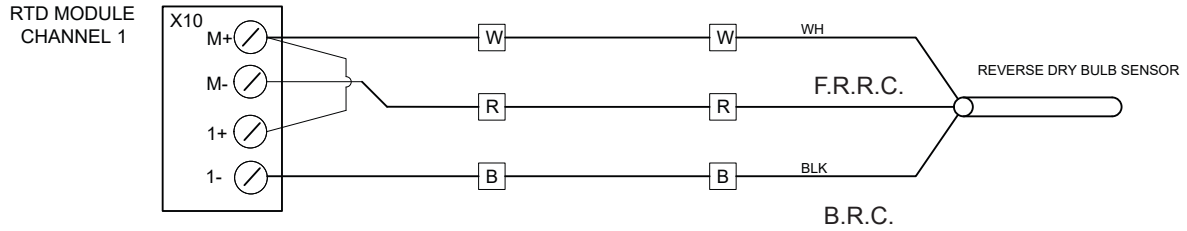
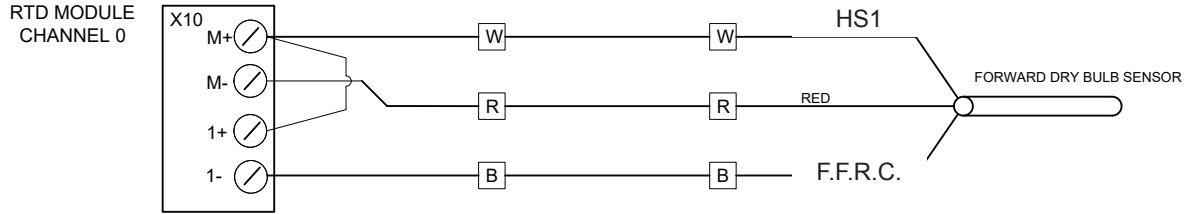
RTD SENSOR INPUTS



 <small>12 Stevens Road Brewer, Maine 04412 Tel: 1-207-888-4335 Int: 1-800-777-6953 Fax: 1-207-888-1101 Email: info@nyle.com</small>	TITLE RTD WIRING	
	PART NUMBER NSC PHT	
DRAWN BY NR	DWG FILE NAME NSC PHT	REV 1.2
CHECKED	SCALE NTS	SHEET 3 OF 4

Output Wiring

INPUTS CONT'D

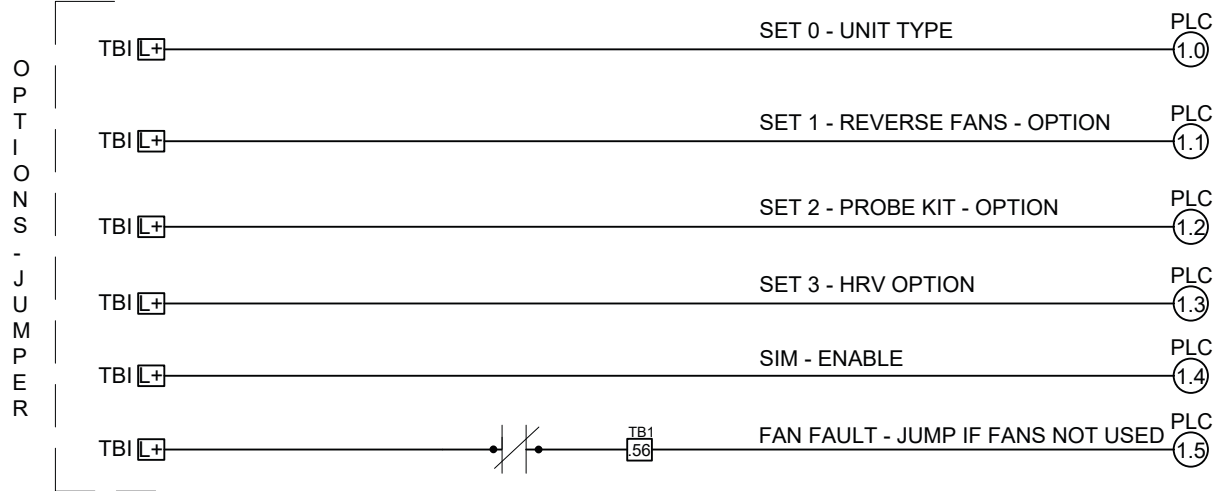

OUTPUTS



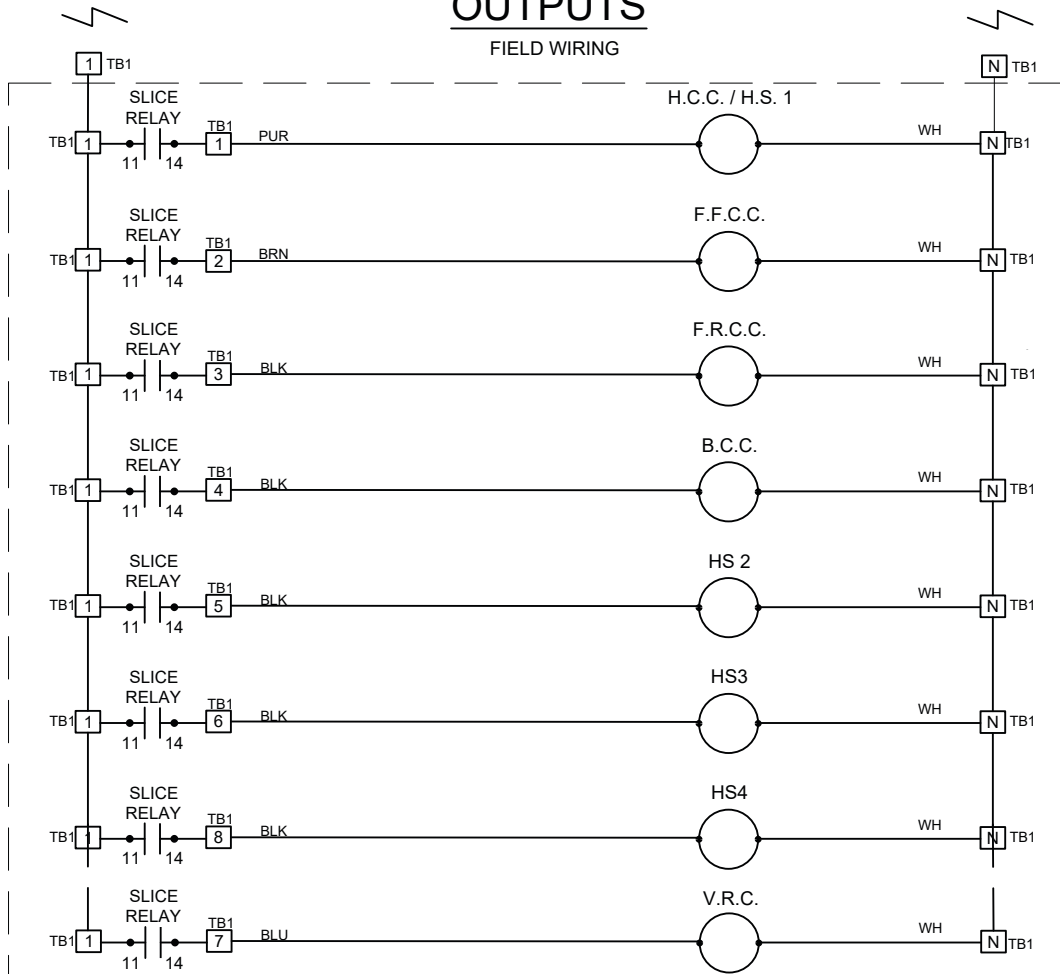



FIELD WIRING



 <small>12 Stevens Road Brewster, Maine 04412 Tel: 1-207-589-4335 ext: 1-800-777-6953 Fax: 1-207-695-1191, Email: info@nyle.com</small>	TITLE OUTPUT WIRING	
	PART NUMBER NSC PHT	
DRAWN BY NR	DWG FILE NAME NSC PHT	REV 1.0
CHECKED	SCALE NTS	SHEET 4 OF 4

Typical Vent Circuits

INSTALLATION NOTES

-  2 Actuators may be connected in parallel. Power consumption and input impedance must be observed.
-  3 Actuators may also be powered by 24 VDC.
-  7 A 500 Ω resistor (ZG-R01) converts the 4 to 20 mA control signal to 2 to 10 VDC.
-  8 Control signal may be pulsed from either the Hot (Source) or Common (Sink) 24 VAC line.
-  9 For triac sink the common connection from the actuator must be connected to the hot connection of the controller. Contact closures A & B also can be triacs. A & B should both be closed for the triac source and open for triac sink.
-  18 Actuators with plenum cable do not have numbers; use color codes instead.

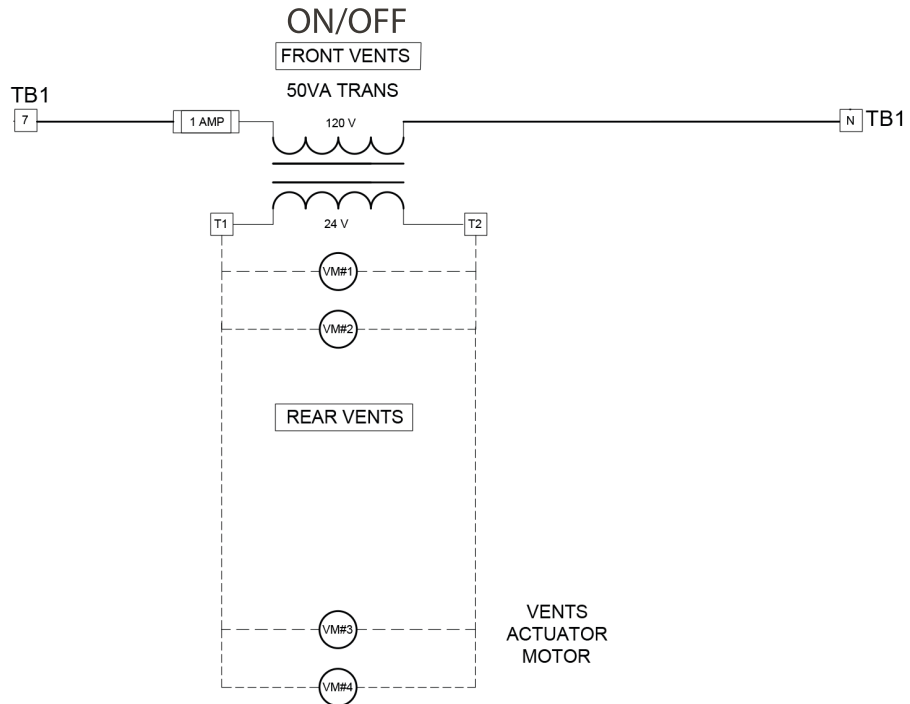
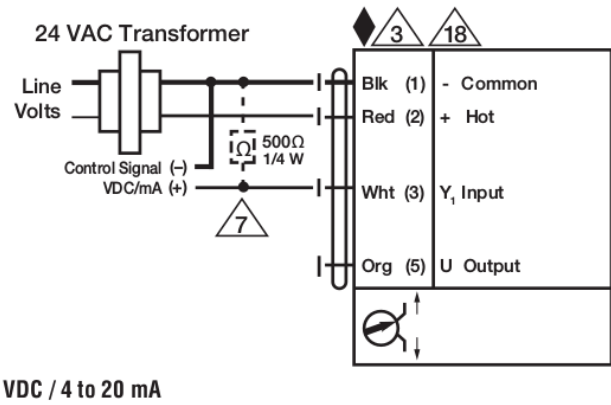

LEGEND

F.F.C.C. - FANS FORWARD CONTACT COIL
F.R.C.C. - FANS REVERSE CONTACT COIL

12 Stevens Road Brewer, Maine 04412 Tel: 1-207-989-4330 Int: 1-800-777-6953 Fax: 1-207-989-1101 Email: info@nyte.com		TITLE
DRAWN BY NR		PART NUMBER
CHECKED	DWG FILE NAME	REV 1.2
	SCALE	SHEET
	NTS	



nyle *Dry Kilns*

© 2020 Nyle Dry Kilns
PHT / FHT Manual V4.1