

nyle
water heating
systems



User Manual
C-Series
Air Source HPWH



TABLE OF CONTENTS

SAFE INSTALLATION, USE AND SERVICE.....	1	TEMPERATURE-PRESSURE RELIEF VALVE.....	12
GENERAL SAFETY INFORMATION.....	2	TANK SELECTION.....	12
PRECAUTIONS.....	2	SOLAR TANKS.....	12
GROUNDING INSTRUCTIONS.....	2	CONTAMINATED AIR.....	13
INTRODUCTION.....	3	STORAGE & HANDLING.....	13
QUALIFICATIONS.....	3	STORAGE RECOMMENDATIONS.....	13
PREPARING FOR THE INSTALLATION.....	3	INSTALLATION.....	14
PRINCIPLE OF OPERATION.....	4	REQUIRED ABILITY.....	14
THE REFRIGERATION CYCLE.....	4	GENERAL.....	14
AIR TEMPERATURE RANGE.....	4	REQUIRED TOOLS & MATERIALS.....	14
WATER TEMPERATURE RANGE.....	4	INSTALLATION & START UP TOOLS.....	14
REFRIGERANT CHARGE.....	4	SERVICE TOOLS.....	14
EQUIPMENT DISPOSAL.....	4	UNIT PLACEMENT.....	14
FEATURES & COMPONENTS.....	5	CEILING SUSPENSION.....	14
PRODUCT ILLUSTRATION.....	5	PAD MOUNTING.....	15
AIR TO WATER CYCLE.....	6	ELECTRICAL CONNECTIONS.....	15
ROUGH IN DIMENSIONS.....	7	CORRECT VOLTAGE AND PHASE.....	15
PERFORMANCE SPECIFICATIONS.....	7	BRANCH CIRCUIT DISCONNECT SWITCH.....	15
INSTALLATION REQUIREMENTS.....	8	TRANSFORMER CONFIGURATION.....	15
WATER TEMPERATURE.....	8	WATER CONNECTIONS.....	15
MAXIMUM SYSTEM TEMPERATURE.....	8	INSTALLATION INSTRUCTIONS.....	15
INLET & OUTLET WATER TEMPERATURE.....	8	SINGLE TANK CONFIGURATION.....	16
AIR TEMPERATURE.....	8	MULTIPLE TANK CONFIGURATION.....	16
ENTERING AIR TEMPERATURE.....	8	CONDENSATE DRAIN LINE.....	16
LOCATING THE WATER HEATER.....	8	STANDARD TANK THERMOSTAT.....	16
INDOOR/OUTDOOR INSTALLATION.....	8	TEMPERATURE SENSOR INSTALLATION.....	17
FREEZING TEMPERATURES.....	8	AIR FLOW AND DUCTING.....	17
COASTAL REGIONS.....	8	GENERAL GUIDELINES.....	17
HEAT SOURCE.....	8	DUCT SIZING.....	17
CONDITIONED SPACE.....	9	DUCT INSULATION.....	17
UNCONDITIONED SPACE.....	9	MAKE DUCT CONNECTIONS.....	17
CLEARANCES.....	9	DUCTING MULTIPLE UNITS.....	17
ELECTRICAL REQUIREMENTS.....	9	BUILDING AIR PRESSURE.....	17
MINIMUM CIRCUIT AMPACITY & MAXIMUM FUSE		NEGATIVE PRESSURE.....	17
SIZE.....	9	POSITIVE PRESSURE.....	17
MINIMUM WIRE SIZE.....	10	WHEN TO INSTALL DUCTING.....	18
WATER PIPING.....	11	SUPPLY AIR DUCTING.....	18
MINIMUM PIPE SIZE.....	11	DUCT SIZING CHART.....	18
PIPE SUPPORT.....	11	RETURN AIR DUCTING.....	19
PIPE INSTALLATION.....	11	BLOWER ASSEMBLY ADJUSTMENTS.....	19
COLD WATER SUPPLY.....	11	INSTALLATION CHECKLIST.....	19
WATER PRESSURE.....	11	LOCATION.....	19
CLOSED WATER SYSTEMS.....	11	AIRFLOW & DUCTING.....	19
THERMAL EXPANSION.....	11	WATER PIPING.....	19
MIXING VALVES.....	11	CONDENSATE DRAIN.....	20
CONDENSATE REMOVAL.....	12	ELECTRICAL.....	20
CONTAMINATED WATER.....	12	PRE-STARTUP CHECKLIST.....	20

TABLE OF CONTENTS





3PHASESTARTUPPROCEDURES.....	20	MEMBER SCREEN TERMINOLOGY.....	29
SINGLEPHASESTARTUPPROCEDURES.....	21	HOME SCREEN.....	29
INITIALSTART-UP.....	22	ALARM SCREEN.....	29
MASTER CONTROL PANEL		CONFIGURATION SCREEN.....	29
PRE-STARTUP CHECKLIST	22	STOP SCREEN.....	30
ROTATION DIRECTION.....	22	IP CONFIGURATION.....	30
STARTING SOUND.....	22	MAINTENANCE AND SERVICE.....	30
START UP.....	22	ROUTINE MAINTENANCE.....	30
SETTING LOWER LIMIT CONTROL		AIR FILTERS.....	30
VALVE LIMIT FOR SINGLE-PASS.....	23	DRAIN PAN.....	30
PURGINGTHECONDENSERONAPLC.....	24	BLOWER ASSEMBLY.....	30
ELECTRONIC TEMPERATURE CONTROLS.....	24	BLOWER MOTOR.....	31
CONTROLLER.....	24	EVAPORATOR COIL.....	31
FUNCTION RANGES & SETTINGS.....	24	CLEANING INTERNAL INSULATION.....	31
PARAMETER SETTINGS.....	24	CHECKING REFRIGERANT CHARGE.....	31
SCREEN NAVIGATION.....	24	CHECK AIR FLOW.....	31
BASIC MODE.....	25	CHECK WATER TEMPERATURE RISE.....	31
ADVANCED MODE.....	25	FACTORY CHARGE.....	32
RESTRICTED MODE.....	25	SUPERHEAT CALCULATION.....	32
PROGRAMMABLE LOGIC CONTROLS.....	25	BRAZE PLATE CLEANING INSTRUCTIONS.....	32
PLC CONTROLLER.....	25	TROUBLESHOOTING.....	33
TEMPERATURE & SETPOINTS.....	26	WATER PIPING DIAGRAMS.....	34
SETPOINTS RANGES & SAFETIES.....	26	LIMITED WARRANTY.....	39
MASTER SCREENS.....	26	SERVICE LOG.....	41
MASTER PANEL HOME SCREEN.....	26		
MASTER PANEL ALARM SCREEN.....	26		
MASTER PANEL CONFIGURATION SCREEN.....	26		
MASTER SCREEN TERMINOLOGY.....	27		
HOME SCREEN.....	27		
ALARM SCREEN TERMINOLOGY.....	27		
CONFIGURATION SCREEN.....	27		
MASTER CONTROL PANEL			
SETUP TO MEMBER UNITS.....	27		
MASTER CONTROL UNIT			
SUPPORT CALL SEQUENCE OF OPERATIONS.....	27		
MEMBER SCREENS.....	28		
SINGLE UNIT HOME SCREEN			
OPERATING. WITH MASTER CONTROLS.....	28		
SINGLE UNIT HOME SCREEN			
OPERATING AS A SINGLE UNIT (IN DEFROST).....	28		
SINGLE UNIT HOME SCREEN			
DISPLAYINGALARMSTATUS.....	28		
SINGLE UNIT ALARM SCREEN.....	28		
SINGLE UNIT PIPE CONFIGURATION SCREEN.....	28		
SINGLE UNIT TANK CONFIGURATION SCREEN.....	28		
SINGLE UNIT IP ADDRESS CONFIGURATION.....	29		
SINGLE UNIT HEAT BANK SCREEN.....	29		

SAFE INSTALLATION, USE AND SERVICE

The proper installation, use and servicing of this commercial heat pump water heater is extremely important to your safety and the safety of others.

Many safety-related messages and instructions have been provided in this manual and on your own heat pump water heater to warn you and others of a potential injury hazard. Read and obey all safety messages and instructions throughout this manual. It is very important that the meaning of each safety message is understood by you and others who install, use, or service this heat pump water heater

	<p>This is the safety alert symbol. It is used to alert you to potential personal injury hazards. Obey all safety messages that follow this symbol to avoid possible injury or death.</p>
---	---

	<p>DANGER indicates an imminently hazardous situation which, if not avoided, will result in injury or death.</p>
	<p>WARNING indicates a potentially hazardous situation which, if not avoided, could result in injury or death.</p>
	<p>CAUTION indicates a potentially hazardous situation which, if not avoided, could result in minor or moderate injury.</p>
	<p>CAUTION used without the safety alert symbol indicates a potentially hazardous situation which, if not avoided, could result in property damage.</p>

All safety messages will generally tell you about the type of hazard, what can happen if you do not follow the safety message, and how to avoid the risk of injury.

The California Safe Drinking Water and Toxic Enforcement Act requires the Governor of California to publish a list of substances known to the State of California to cause cancer, birth defects, or other reproductive harm, and requires businesses to warn of potential exposure to such substances.

This product contains a chemical known to the State of California to cause cancer, birth defects, or other reproductive harm. This appliance can cause low level exposure to some substances listed in the Act.

GENERAL SAFETY INFORMATION

PRECAUTIONS

****DO NOT USE THIS UNIT IF ANY PART HAS BEEN UNDER WATER.****

Immediately call a qualified service agency to inspect the unit and make a determination on what steps should be taken next.

If the unit is exposed to the following, do not operate heater until all corrective steps have been made by a qualified service agency.

1. External fire.
2. Damage.
3. Running without water .

GROUNDING INSTRUCTIONS

This heat pump water heater must be grounded in accordance with the National Electrical Code and/or local codes. These must be followed in all cases. Failure to ground this water heater properly may also cause erratic control system operation.

This heat pump water heater must be connected to a grounded metal, permanent wiring system; or an equipment grounding conductor must be run with the circuit conductors and connected to the equipment grounding terminal or lead on the water heater.

When servicing this unit, verify the power to the unit is turned off prior to opening the control cabinet door.

⚠ WARNING

CONTAINS REFRIGERANT!

System contains oil and refrigerant under high pressure. Recover refrigerant to relieve pressure before opening the system. See unit rating label for refrigerant type. Do not use non-approved refrigerants, refrigerant substitutes, or refrigerant additives.

Failure to follow proper procedures or the use of non-approved refrigerants, refrigerant substitutes, or refrigerant additives could result in death or serious injury or equipment damage.

⚠ DANGER

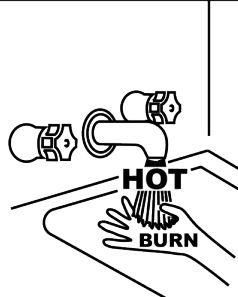

Water temperature over 125°F (52°C) can cause severe burns instantly resulting in severe injury or death.

Children, the elderly and the physically or mentally disabled are at highest risk for scald injury.

Feel water before bathing or showering.

Temperature limiting devices such as mixing valves must be installed when required by codes and to ensure safe temperatures at fixtures.

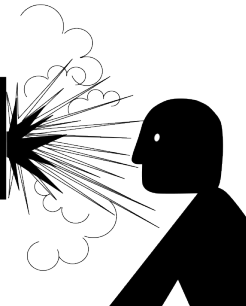

⚠ WARNING

Explosion Hazard

- Do not use oxygen to purge or pressurize system for leak test.
- Oxygen reacts violently with oil, which can cause an explosion resulting in severe personal injury or death.



⚠ WARNING

Read and understand this instruction manual and the safety messages herein before installing, operating or servicing this water heater.

Failure to follow these instructions and safety messages could result in death or serious injury.

This manual must remain with the water heater.



⚠ WARNING

Electrical Shock Hazard

- Turn off power to the water heater before performing any service.
- Label all wires prior to disconnecting when performing service. Wiring errors can cause improper and dangerous operation.
- Verify proper operation after servicing.
- Failure to follow these instructions can result in personal injury or death.

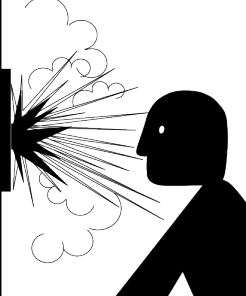

⚠ WARNING

Explosion Hazard

- Overheated water can cause water tank explosion.
- Properly sized temperature and pressure relief valve must be installed in the opening provided on connected storage tanks.

INTRODUCTION

Thank you for purchasing this heat pump water heater. Properly installed and maintained, it should give you years of trouble free service.

Abbreviations found In this Instruction Manual include:

- HPWH - Heat Pump Water Heater
- ANSI - American National Standards Institute
- ASME - American Society of Mechanical Engineers
- NEC - National Electrical Code
- NFPA - National Fire Protection Association
- AHRI - Air-conditioning, Heating and Refrigeration Institute

QUALIFICATIONS

QUALIFIED INSTALLER OR SERVICE AGENCY:

Installation and service of this water heater requires ability equivalent to that of a Qualified Agency (as defined by ANSI below) in the field involved Installation skills such as plumbing, electrical supply are required in addition to electrical testing skills when performing service.

This heat pump water heater contains R-134a refrigerant and is regulated as a stationary refrigeration appliance under Section 608 of the Clean Air Act. Servicing of the refrigeration circuit must only be performed by agencies or individuals possessing Type II or Universal certification as defined in Section 608 of the Clean Air Act.

ANSI Z223.1 2006 Sec. 3.3.83: "Qualified Agency" - "Any individual, firm, corporation or company that either in person or through a representative is engaged in and is responsible for (a) the installation, testing or replacement of gas piping or (b) the connection, installation, testing, repair or servicing of appliances and equipment; that is experienced in such work; that is familiar with all precautions required; and that has complied with all the requirements of the authority having jurisdiction."

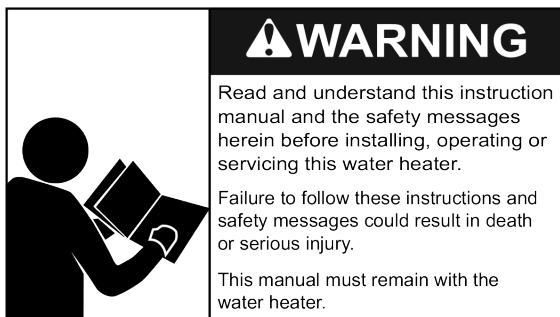

PREPARING FOR THE INSTALLATION

1. Read the "General Safety Information" section of this manual First and then the entire manual carefully. If you don't follow the safety rules, the heat pump water heater may not operate safely. It could cause DEATH, SERIOUS BODILY INJURY AND/OR PROPERTY DAMAGE.

This manual contains instructions for the installation, operation, and maintenance of the heat pump water heater (HPWH). It also contains warnings throughout the manual that you must read and be aware of. All warnings and all instructions are essential to the proper operation of the HPWH and your safety.

READ THE ENTIRE MANUAL BEFORE ATTEMPTING TO INSTALL OR OPERATE THIS WATER HEATING APPLIANCE.

Detailed installation diagrams are in this manual. These diagrams will serve to provide the installer with a reference for the materials and suggested methods of piping. IT IS NECESSARY THAT ALL WATER PIPING AND THE ELECTRICAL WIRING BE INSTALLED AND CONNECTED AS SHOWN IN THE DIAGRAMS.

Particular attention should be given to the installation of the system (tank) temperature control. See page 17.

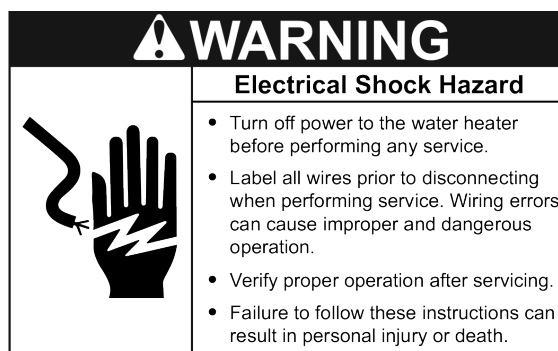

Be sure to turn off power when working on or near the electrical system of the heat pump. Never touch electrical components with wet hands or when standing in water. When replacing fuses always use the correct size for the circuit.

The principal components of the HPWH are identified in the Features And Components section of this manual on page 5. The rating label on the HPWH also provides useful information. These references should be used to identify the heat pump, its components and optional equipment.

2. The installation must conform with these instructions and the local code authority having jurisdiction and the requirements of the power company. In the absence of local codes, the installation must comply with the latest editions of the National Electrical Code, ANSI/NFPA 70 or the Canadian Electrical Code CSA C22.1. The National Electrical Code may be ordered from: National Fire Protection Association, 1 Batterymarch Park, Quincy, MA 02269.

The Canadian Electrical Code is available from the Canadian Standards Association, 8501 East Pleasant Valley Road, Cleveland, OH 44131.

3. If after reading this manual you have any questions or do not understand any portion of the instructions DO NOT proceed with the installation. Call the toll free number listed on the back page of this manual for technical assistance.

4. In order to expedite your request, please have full model and serial number available for the technician.
5. Carefully consider your intended placement and location for the HPWH. See *Locating The Water Heater* on page 9.
6. Installation and service of this HPWH requires ability equivalent to that of a licensed tradesman or Qualified Agency in the field involved. See *Qualifications* on page 3.
7. For installation in California the HPWH unit must be braced or anchored to avoid falling or moving during an earthquake. Instructions may be obtained from California Office of the State Architect, 1102 Q Street, Suite 5100, Sacramento, CA 95811.
8. Ensure the power supply voltage and phase at the job site matches the power requirements on the HPWH rating label before installation begins. Energizing the HPWH with the wrong voltage or phase will cause permanent damage to the unit.

PRINCIPLE OF OPERATION

The units covered by this Instruction Manual are commercial modular air-to-water heat pump water heaters (HPWH).

Operation of the HPWH is similar to that of a package air conditioning system. The primary difference in operation is that the HPWH unit utilizes the heat removed from the conditioned or ambient space to heat water where package air conditioning systems discard this heat outdoors. Recovering and using this waste heat increases the overall energy efficiency of the building.

THE REFRIGERATION CYCLE

Refer to Figure 1 and the AIR TO WATER CYCLE on pages 5 & 6 for the location of components mentioned in this section.

Refrigerant is circulated through the refrigeration circuit by a *Compressor*. The refrigerant is a high temperature high pressure gas when it leaves the compressor. Refrigerant flows from the compressor through the *Hot Gas Line* to the *Condenser*.

The condenser is a refrigerant-to-water heat exchanger with two circuits, refrigerant flows through one circuit and water through the other. The high temperature refrigerant gas transfers its heat to the water flowing through the condenser. As the refrigerant gas cools inside the condenser it changes state (condenses) from a gas to a liquid. An integrated hot water circulator pump is provided from the factory which is sized for a short pipe run, this pump circulates water through the condenser.

Refrigerant leaving the condenser is a medium temperature high pressure liquid. It flows through the *Liquid Line* to the *Thermostatic Expansion Valve*. The thermostatic expansion valve (TXV) flashes the liquid to a gas/liquid state which helps to ensure all of the refrigerant is in a gaseous state by the time it exits the evaporator to protect the compressor. The evaporator is a tube-and-fin constructed coil. It is an air- to-refrigerant heat exchanger with refrigerant flowing through the tubes and air flowing across the fins.

The *Blower* moves ambient air from the installed space or air ducted to the HPWH from another location across the fins of evaporator coil. The refrigerant absorbs heat from the air in the evaporator. The refrigerant changes state (boils/evaporates) from a liquid state back into a gas (vapor) in the evaporator.

The refrigerant flows out of the evaporator through the *Suction Line* and into the *Accumulator*. The accumulator traps any liquid refrigerant the evaporator is unable to vaporize during low temperature operating conditions. The accumulator prevents liquid refrigerant from entering the compressor where it could damage internal components.

Low temperature low pressure refrigerant gas (vapor) is drawn out of the accumulator by the compressor. The compressor increases the pressure and temperature of the refrigerant gas circulating it to the condenser again where the refrigeration cycle starts over or continues.

AIR TEMPERATURE RANGE

The entering air temperature operating range for the HPWH is 40°F to 120°F (4°C to 49°C).

When the HPWH is operating properly the air temperature drop through the evaporator (heat exchanger) will be approximately 12°F to 20°F (7°C to 11°C).

WATER TEMPERATURE RANGE

The inlet (entering) water temperature operating range for the HPWH is 40°F to 140°F (4°C to 60°C). The HPWH will heat potable water up to 160°F. When the HPWH is operating properly the water temperature rise through the condenser (heat exchanger) will be approximately 8°F to 12°F (4°C to 7°C).

REFRIGERANT CHARGE

The HPWH is factory-charged with R-134a refrigerant. The refrigerant charge is weighed in at the factory. See Table 9 on page 32. It should not be necessary to add or remove refrigerant during installation or start up.

EQUIPMENT DISPOSAL

This heat pump water heater contains R-134a refrigerant and is regulated as a stationary refrigeration appliance under Section 608 of the Clean Air Act. Disposal of this unit must be performed in accordance with the provisions in Section 608 of the Clean Air Act and any state or local regulations that may also apply. See *Qualifications* on page 3.

FEATURES & COMPONENTS

PRODUCT ILLUSTRATION

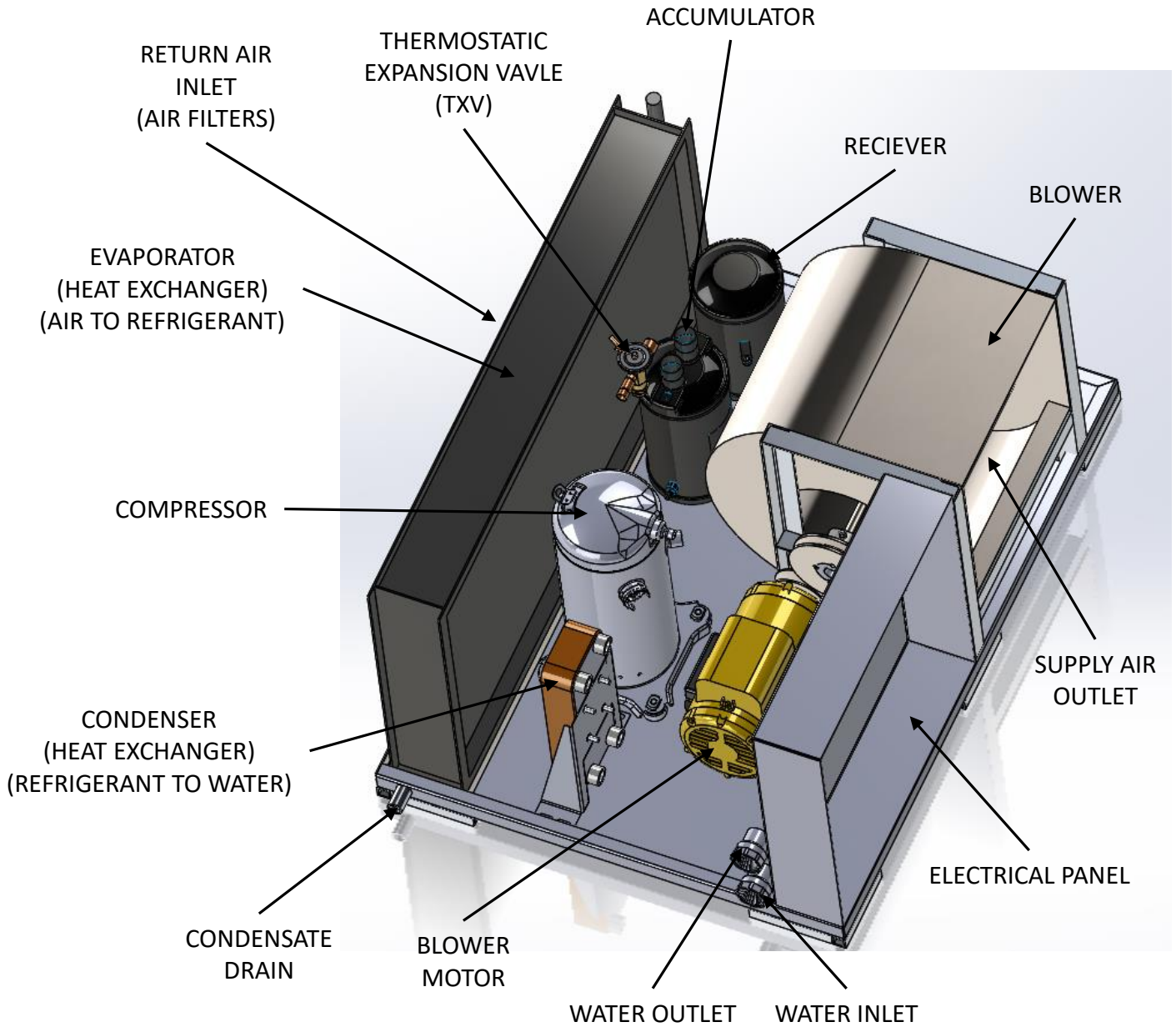

Figure 1

Component Refrigeration Circuit

Compressor
 Condenser (Heat Exchanger)
 Receiver
 Thermostatic Expansion Valve (TXV)
 Evaporator (Heat Exchanger)
 Accumulator

Refrigerant State

Gas
 Gas to Liquid
 Liquid
 Liquid
 Liquid to Gas
 Gas / Liquid

Component Water Circuit

Water Inlet
 Condenser (Heat Exchanger)
 Water Outlet

AIR TO WATER CYCLE

AIR TO WATER COMPRESSION CYCLE

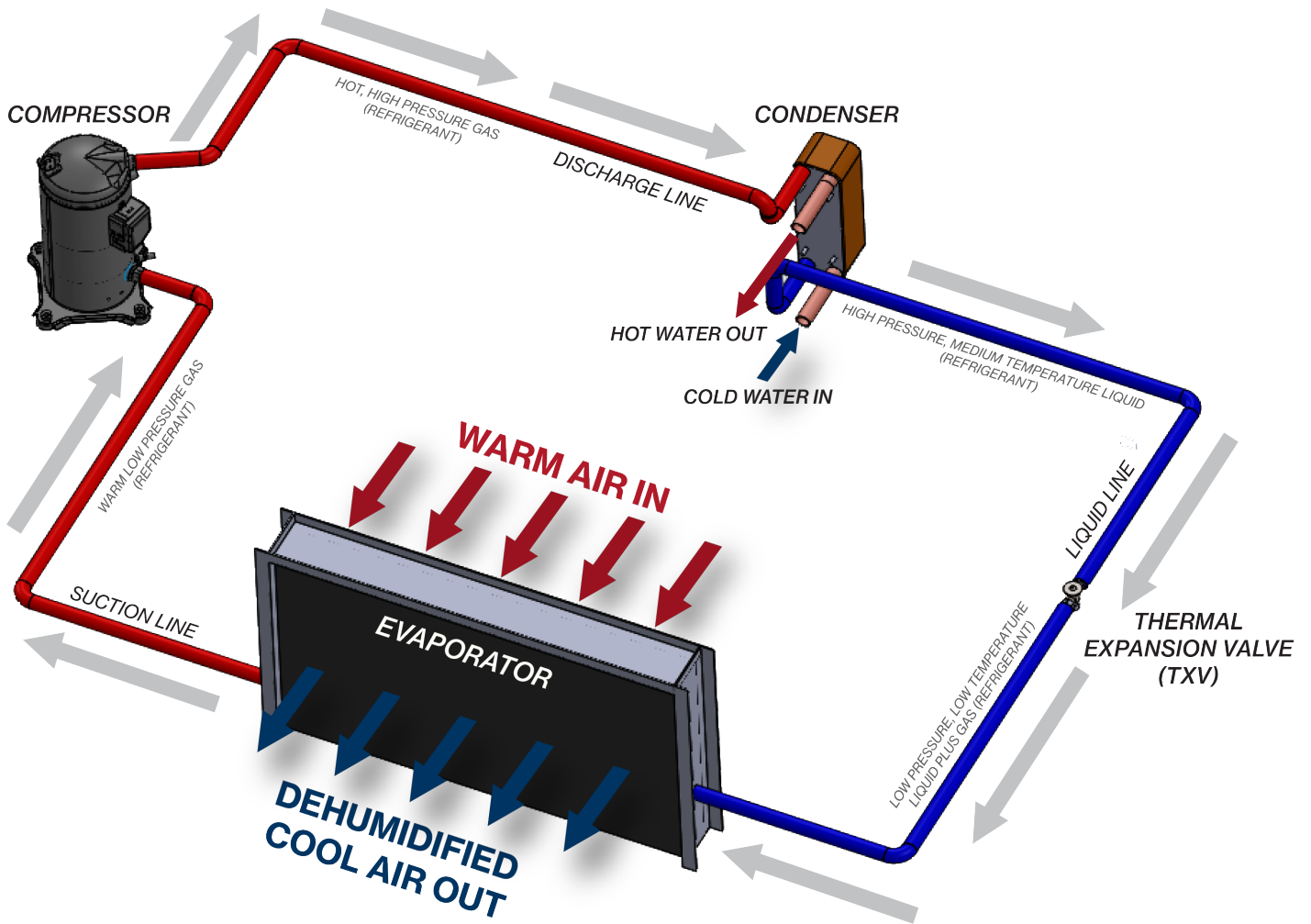

ROUGH IN DIMENSIONS

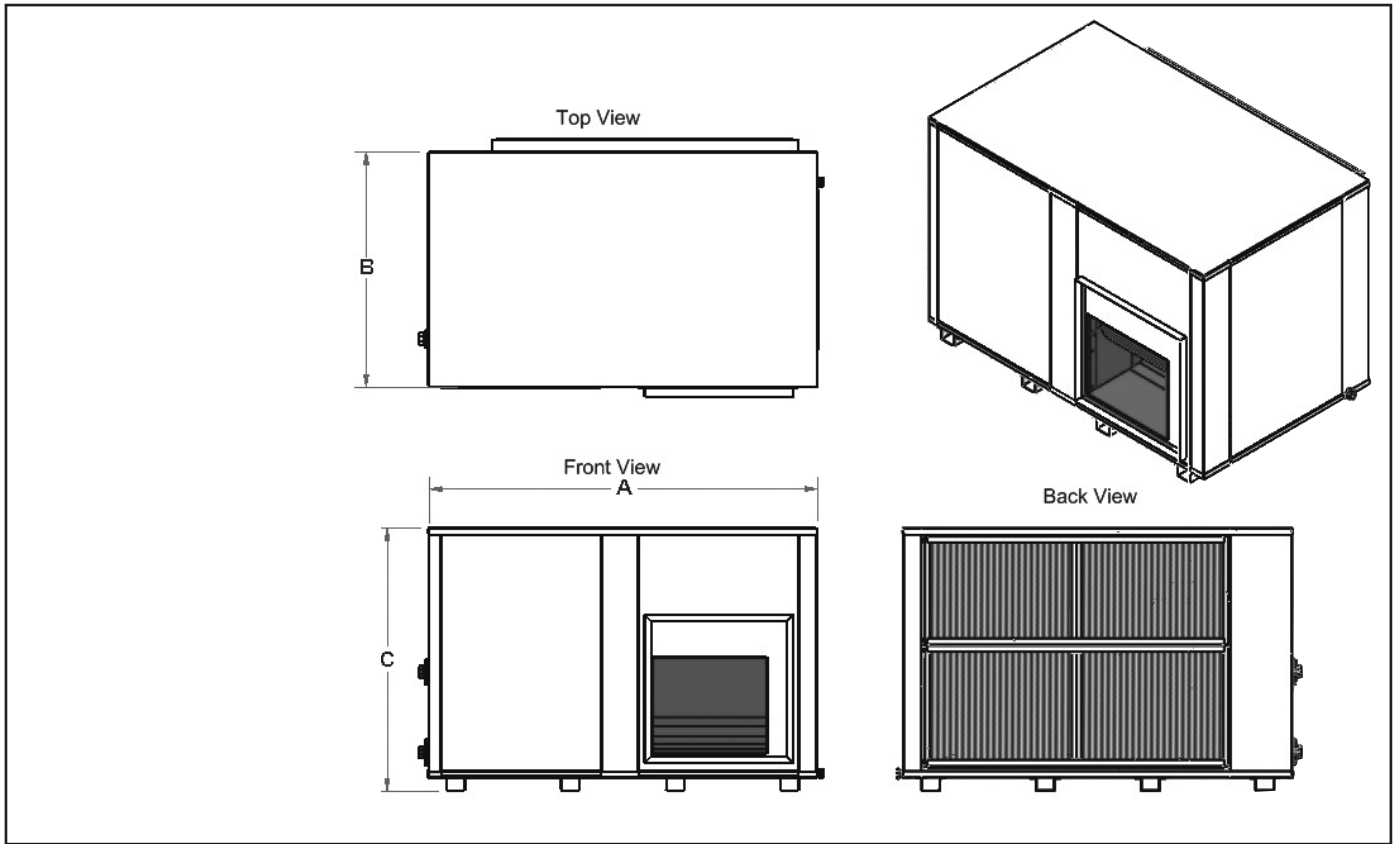

Figure 2

PERFORMANCE SPECIFICATIONS

TABLE 1

Model Number	Water Flow Rate (GPM)		Performance						Air Volume (CFM)	Dimensions				Weight	
			Water Heating Capacity		Cooling Capacity		Combined C.O.P	Inlet Outlet Water (FPT)		Length x Width x Height (A x B x C)		Dry Weight (LBS)	Operating Weight (LBS)		
	Single Pass**	Multi Pass	BTUH	Heating C.O.P	BTUH	Cooling C.O.P				Single Pass	Multi Pass			Axial	Blower
C25A	2.5	5.4	27,450	5.18	21,200	4.20	9.38	1,250	¾"	¾"	45½" x 33" x 24½"	45½" x 31½" x 24½"	300	310	
C60A	6	13	63,225	5.05	48,425	4.13	9.18	2,800	1"	1"	64¼" x 32½" x 34½"	64¼" x 29½" x 34½"	500	520	
C90A	9	20	110,725	5.25	83,625	4.15	9.40	2,800	1"	1½"	70¼" x 32¾" x 40¼"	70¼" x 29¾" x 40¼"	750	775	
C125A	12.5	28	144,275	4.93	108,500	3.98	8.91	4,500	1"	1½"	84¾" x 37¼" x 36½"	84¾" x 34¾" x 36½"	1,200	1,240	
C185A	18.5	40	224,675	5.33	172,375	4.33	9.66	4,500	1½"	2"	72¾" x 45¼" x 43"	72¾" x 42¾" x 43"	1,350	1,410	
C250A	25	50	272,450	4.58	218,000	3.88	8.46	8,000	1½"	2"	84½" x 54¾" x 70"	84½" x 54¾" x 67½"	2,100	2,175	

All dimensions are in Inches. Weights are approximate shipping weights.

*Performance rating at 75° F Entering Air Temperature and 60% Relative Humidity

**Water Heated from 50° F to 150° F

** Single Pass design flow rates are shown above, the actual flow rate to heat water from 50° F to 150° F is much lower.

COP = Coefficient Of Performance

Standard Voltage on C25A & C60A models - 208/230 V, 1-phase, 60Hz

Standard Voltage on C90A - C250A models - 208/230 V, 3-phase, 60Hz

Other power options are available upon request

LOCATION OF THE HEATED WATER CONNECTIONS COULD VARY BY UNIT,
SEE MANUFACTURER DOCUMENTS FOR EACH INDIVIDUAL UNIT.

INSTALLATION REQUIREMENTS

Read all installation requirements in this manual before installation begins. The installation must conform to these instructions and all local and national code authority having jurisdiction.

Costs to diagnose, perform service and repair damage caused by installation errors are not covered under the limited warranty.

Costs to correct installation errors are not covered under the limited warranty.

WATER TEMPERATURE

MAXIMUM SYSTEM TEMPERATURE

The HPWH units covered in this manual are capable of maintaining a maximum system/storage tank temperature of 150°F (66°C). Some commercial water heating applications may require higher temperatures. Install a booster water heater downstream from the storage tank for temperatures above 150°F (66°C). See Figure 8 on page 16

INLET & OUTLET WATER TEMPERATURE

The inlet (entering) water temperature operating range for the HPWH is 40°F to 140°F (4.4°C to 60°C). The water temperature rise (Delta T - ΔT) through the condenser (heat exchanger) will be approximately 8°F to 12°F (4°C to 7°C).

Outlet water temperatures up to 152°F (67°C) are possible during normal operation. Exposure to water temperatures this high can cause serious bodily injury or death. See Mixing Valves and Table 5 on pages 11 & 12.

Service & Installation Notes:

If the inlet (entering) water temperature is outside the operating temperature range for extended periods the control system may lock out on high or low refrigerant pressure switch events/trips.

When the control system locks out on a refrigerant pressure switch event the compressor will stop running, the blower and circulation pump (on models equipped with factory installed pump) will continue to operate. This is a hard lock out condition. The control system is manually reset by cycling power to the HPWH off and then on again.

The tank thermostat must not be set any higher than 150°F (66°C) to prevent control system lock outs.

Ground water temperatures can fall below 50°F (10°C) for extended periods during winter months in many regions. For this reason the cold water supply lines and should not be connected directly to the HPWH inlet or T fitted into the inlet (return) water piping. The cold water supply lines should be connected directly to the storage tank only. See the Piping Diagrams on page 34 in this manual for more information.

AIR TEMPERATURE

ENTERING AIR TEMPERATURE

The return (entering) air temperature range of operation for the unit is 40° - 120°F (4.4°C to 48.9°C). The air temperature drop (Delta T - ΔT) through the evaporator (heat exchanger) will be approximately 12°F to 20°F (7°C to 11°C).

If the entering air temperature is outside this operating range the HPWH unit's Ambient Air Limit Thermostat will discontinue heating operation until the entering air temperature returns to this operating range. **(If the evaporator is equipped with Heating Elements, they will kick on to bring up the ambient temperature).**

LOCATING THE WATER HEATER

CAUTION	
PROPERTY DAMAGE!	
<ul style="list-style-type: none">• All water heaters may eventually leak.• Do not install without adequate drainage.	

INDOOR/OUTDOOR INSTALLATION (Milder Climates)

Carefully choose a location for the HPWH unit. Placement is a very important consideration for optimal performance and safety.

Locate the HPWH near a floor drain. The unit should be located in an area where leakage from the HPWH unit or the storage tank it is connected to will not result in damage to the area adjacent to the water heater or to lower floors of the structure. See Unit Placement on page 14.

FREEZING TEMPERATURES

The HPWH unit must not be installed in space where freezing temperature will occur, without a low ambient air kit. Exposure to freezing ambient temperatures below 32°F (0° C) may result in severe damage to internal components. Damage caused by exposure to freezing temperatures is not covered under the limited warranty.

COASTAL REGIONS

"All Air-Source HPWHs come standard with an outdoor rated coating. This coating will prevent premature wear on HPWHs. The epoxy and polyurethane system has a salt spray/fog rating of 9,000 hours and performs well in harsh environments ensuring the coatings never dull and remain intact ensuring a durable finish."

HEAT SOURCE

The HPWH unit should be located where there is an adequate source of ambient heat and where the cooling benefit can be

utilized when possible. If installation in a space with an adequate heat source is not possible the HPWH unit can be ducted to/from another space such as a boiler room or to the outdoors where sufficient heat is available. See Air Flow and Ducting on page 17.

CONDITIONED SPACE

When installed in a conditioned space ducting supply (outlet) air to an alternate location may be necessary to avoid over-cooling of the space where the HPWH is installed or provide spot cooling in areas for comfort and/or to offset cooling load. See Building Air Pressure, Air Flow and Ducting on page 17.

UNCONDITIONED SPACE

When installed in an unconditioned space ducting return (inlet) air from an alternate location may be necessary to access an adequate or greater source of heat for optimal efficiency. See Building Air Pressure, Air Flow and Ducting on page 17.

CLEARANCES

To ensure optimal performance a minimum of 30 inches clearances required from the back, left and right sides of the HPWH unit and any wall obstruction. A minimum of 36 inches clearance on the front of the unit for access to the control box.

When installed on an equipment pad the HPWH must be level and elevated at least 6" above floor to avoid dust and debris and permit connection of the condensate line and trap.

ELECTRICAL REQUIREMENTS

Ensure the power supply voltage and phase at the job site matches the power supply ratings listed on the HPWH data sticker label BEFORE INSTALLATION BEGINS.

The installation must conform with these instructions and the local code authority having jurisdiction and the requirements of the power company. In the absence of local codes, the installation must comply with the current editions of the National Electrical Code, ANSI/NFPA 70 or the Canadian Electrical Code CSA C22.1.

Voltage applied to the HPWH should not vary more than +5% to -10% of the voltage requirement listed on the HPWH rating label for satisfactory operation.

MINIMUM CIRCUIT AMPACITY & MAXIMUM FUSE SIZE

Table 2 provides the MCA (Minimum Circuit Ampacity) and MFS (Maximum Fuse Size). Use MCA to select the minimum field wires size to power the unit and MFS to select the maximum fuse size for over current protection as follows:

$$MCA = C \times 1.25 + M + P$$

$$MFS = C \times 2.25 + M + P$$

Where:

C - Compressor RLA

M - Blower Motor FLA

P - Pump FLA

TABLE 2 - VOLTAGE & AMPERAGE RATINGS

Model	Volts/Phase/HZ	Compressor			Fan Motor		Blower Motor		Pump	Fan HPWH		Blower HPWH	
		RLA	MCC	HP	FLA	HP	FLA	HP	FLA	MCA	MFS	MCA	MFS
C25A	208-230/1/60	16.0	25.0	2.5	2.3	0.17	6.50	1.0	1.40	24	25	28	30
	208-230/3/60	9.0	14.0	2.5	1.1	0.17	4.00	1.0	1.40	14	15	17	20
	440-480/3/60	4.5	7.0	2.5	0.6	0.17	2.00	1.0	1.40	8	10	10	15
	575/3/60	3.8	6.0	3.0	1	0.50	1.20	1.0	1.40	8	10	8	10
C60A	208-230/1/60	28.2	44.0	5.5	3	0.33	6.20	1.5	1.90	41	15	44	15
	208-230/3/60	20.2	31.5	6.0	1.8	0.33	4.40	1.5	1.90	29	30	32	35
	440-480/3/60	9.1	14.2	6.0	1	0.33	2.20	1.5	1.90	15	20	16	20
	575/3/60	7.1	11.0	6.0	1	0.50	1.80	1.5	1.90	12	15	13	15
C60A-jr	208-230/1/60	28.2	44.0	5.5	N/A	N/A	4.50	0.5	1.90	N/A	N/A	42	45
C90A	208-230/3/60	35.3	55.0	10.0	2.1	0.33	4.40	1.5	1.90	49	50	51	60
	440-480/3/60	17.9	28.0	10.0	1	0.33	2.20	1.5	1.90	26	30	27	30
	575/3/60	11.5	18.0	10.0	1	0.50	1.80	1.5	1.90	18	20	19	20
C125A	208-230/3/60	48.1	75.0	13.0	3	0.75	8.40	3.0	4.90	69	70	74	80
	440-480/3/60	21.8	34.0	13.0	1.5	0.75	4.20	3.0	4.90	34	35	37	40
	575/3/60	18.6	29.0	13.0	1.2	0.75	3.30	3.0	4.90	30	35	32	35
C185A	208-230/3/60	73.1	114.0	20.0	3	1.00	8.40	3.0	4.90	100	110	105	110
	440-480/3/60	30.1	47.0	20.0	1.5	1.00	4.20	3.0	4.90	45	50	47	50
	575/3/60	24.4	38.0	20.0	1.2	1.00	3.30	3.0	4.90	37	40	39	40
C250A	208-230/3/60	90.7	127.0	25.0	2.7	0.50	13.53	5.0	2.00	119	125	129	150
	440-480/3/60	45.7	64.0	25.0	1.2	0.50	6.12	5.0	1.00	60	70	65	70
	575/3/60	37.9	65.0	25.0	1	0.50	5.30	5.0	1.00	50	60	54	60

RLA: Running Load Amps

LRA: Locked Rotor Amps

MCC: Maximum Continuous Current

FLA: Full Load Amps

HP: Horse Power

MCA: Minimum Current Ampacity

MFS: Maximum Fuse Size

All Shown MFS Values Are Rounded up to the Nearest Common Fuse Size.

CAUTION

CORRECT POWER SUPPLY!

- Ensure the power supply at the job site matches the voltage and phase listed on the HPWH rating label before connecting power to the HPWH unit.
- Energizing the HPWH with the wrong voltage or phase will cause permanent damage to the HPWH unit.
- Damage caused to the HPWH as the result of applying the wrong voltage or phase is not covered under the limited warranty.

MINIMUM WIRE SIZE

Allowable Ampacities of Insulated Conductors

Single-phase heat pump water heaters are two wire circuits. Three-phase heaters are three wire circuits. In addition to the foregoing, a grounded conductor is required. Not more than three conductors in raceway, cable, or earth (directly buried), based on ambient temperature of 30°C (86°F)

WARNING



Electrical Shock Hazard

- Before removing any access panels or servicing the water heater, make sure the electrical supply to the water heater is turned "OFF."
- Failure to do this could result in death, serious bodily injury, or property damage.

TABLE 3

Size	Temperature Rating of Conductor								Size
	60°C (140°F)	75°C (167°F)	85°C (185°F)	90°C (194°F)	60°C (140°F)	75°C (167°F)	85°C (185°F)	90°C (194°F)	
AWG	TYPES RUW, T TW, UF	TYPES FEPW, RH, RHW, RUH, THW	TYPES V, MI,	TYPES TA, TBS, SA, AVB, SIS, +FEP, +FEPB, +RHH, +THHN, +XHHW*	TYPES RUW, T TW, UF	TYPES RH, RHW, RUH, THW, THWN, XHHW, USE	TYPES V, MI,	TYPES TA, TBS, SA, AVB, SIS, +RHH, +THHN, +XHHW*	AWG
MCM		THWN, XHHW, USE, ZW							MCM
COPPER					ALUMINUM OR COPPER-CLAD ALUMINUM				
18	21
16	22	22
14	15	15	25	25
12	20	20	30	30	15	15	25	25	12
10	30	30	40	40	25	25	30	30	10
8	40	45	50	50	30	40	40	40	8
6	55	65	70	70	40	50	55	55	6
4	70	85	90	90	55	65	70	70	4
3	80	100	105	105	65	75	80	80	3
2		115	120	120	75	90	95	95	2
1		130	140	140		100	110	110	1
0		150	155	155		120	125	125	0
00		175	185	185		135	145	145	00
000		200	210	210		1155	165	165	000
0000		230	235	285		180	185	185	0000
250		255	270	270		205	215	215	250
300		285	300	300		230	240	240	300
350		310	325	325		250	260	260	350
400		335	360	360		270	290	290	400
500		380	405	405		310	330	330	500
CORRECTION FACTORS									
Ambient Temp. °C	For ambient temperatures over 30°C, multiply the ampacities shown above by the appropriate correction factor to determine the maximum allowable load current.								Ambient Temp. °F
31-40	.82	.88	.90	.91	.82	.88	.90	.91	86-104
41-50	.58	.75	.80	.82	.58	.75	.80	.82	105-122
51-6058	.67	.7158	.67	.71	123-141
61-7035	.52	.5835	.52	.58	142-158
71-8030	.4130	.41	159-176

+The load current rating and the over current protection for these conductors shall not exceed 15 amperes for 14 AWG, 20 amperes for 12 AWG and 30 amperes for 10 AWG copper; or 15 amperes for 12 AWG and 25 amperes for 10 AWG aluminum and copper-clad aluminum.

*For dry locations only. See 75°C column for wet locations.

WATER PIPING

Read all installation requirements in this manual before installation begins.

The water piping installation must conform to these instructions and to all local and national code authority having jurisdiction.

Costs to diagnose, perform service and repair damage caused by installation errors are not covered under the limited warranty.

Costs to correct installation errors are not covered under the limited warranty.

MINIMUM PIPE SIZE

The inlet (return) and outlet (supply) water piping installed between the HPWH unit and the storage tank must not be smaller than the water connection sizes on the HPWH. See Table 4, below, for water line connection sizes and water flow rates.

Water line sizing is a critical installation requirement. Installing undersized water piping between the storage tank and the HPWH unit will cause insufficient water flow and will have an adverse impact on performance and equipment life.

TABLE 4

Water Connection and Flow				
Unit	Water Flow Rate (GPM)		Connection Size (Inches)	
	Single Pass	Multi Pass	Single Pass	Multi Pass
C25A	2.5	5.4	¾"	¾"
C60A	6	13	1"	1"
C90A	9	20	1"	1½"
C125A	12.5	28	1"	1½"
C185A	18.5	40	1½"	2"
C250A	25	50	1½"	2"

PIPE SUPPORT

All water piping must be properly supported per local code requirements.

PIPE INSULATION

All piping installed between the HPWH unit and the storage tank must be insulated.

COLD WATER SUPPLY

Cold water supply lines should not be connected directly to the HPWH inlet or T fitted into the inlet (return) water piping. The cold water supply lines should be connected directly to the storage tank only. See Inlet & Outlet Water Temperature on page 8 and Figure 7 and Figure 8 on page 16.

WATER PRESSURE

System water pressure should be maintained between 40 and 60 PSI. Local code may require, and the manufacturer recommends, installing a pressure reducing valve (PRV) in the cold water supply to the building to maintain consistent water pressure.

CLOSED WATER SYSTEMS

Water supply systems may, because of code requirements or such conditions as high line pressure, among others, have installed devices such as pressure reducing valves, check valves, and back flow preventers. Devices such as these cause the water system to be a closed system.

THERMAL EXPANSION

As water is heated, it expands (thermal expansion). In a closed system the volume of water will grow when it is heated. As the volume of water grows there will be a corresponding increase in water pressure due to thermal expansion. Thermal expansion can cause premature failure (leakage) of storage tanks, water heaters and HPWH components such as the condenser. Leakage caused by thermal expansion is not covered under the HPWH limited warranty.

Thermal expansion can also cause intermittent Temperature-Pressure Relief Valve operation: water discharged due to excessive pressure build up. The Temperature-Pressure Relief Valve is not intended for the constant relief of thermal expansion.

A properly sized thermal expansion tank must be installed on all closed systems to control the harmful effects of thermal expansion. Contact a local plumbing service agency to have a thermal expansion tank installed on all closed water systems.

MIXING VALVES

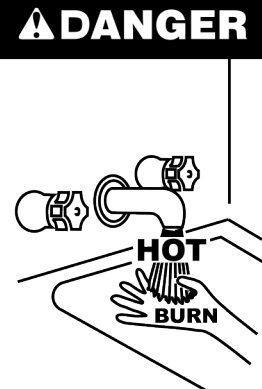

⚠ DANGER Water temperature over 125°F (52°C) can cause severe burns instantly resulting in severe injury or death.

Children, the elderly and the physically or mentally disabled are at highest risk for scald injury.

Feel water before bathing or showering.

Temperature limiting devices such as mixing valves must be installed when required by codes and to ensure safe temperatures at fixtures.

Water heated to a temperature which will satisfy clothes washing, dish washing, and other sanitizing needs can scald and cause permanent injury upon contact. See Table 5, page 12.

Some people are more likely to be permanently injured by hot water than others. These include the elderly, children, the infirm and the physically/mentally disabled. The Table below shows the approximate time-to-burn relationship for normal adult skin. If anyone using hot water provided by the water heater being installed fits into one of these groups or if there is a local code or state law requiring a certain water temperature at the point of use, then special precautions must be taken.

In addition to using the lowest possible temperature setting that satisfies the demand of the application a Mixing Valve

should be installed upstream from the building fixtures or at the hot water taps to further reduce system water temperature.

Mixing valves are available at plumbing supply stores. Consult a Qualified Installer or Service Agency. Follow the mixing valve manufacturer's instructions for installation of the valves.

TABLE 5

Water Temperature	Time to Produce 2nd & 3rd Degree Burns on Adult Skin
180°F (82°C)	Nearly instantaneous
170°F (77°C)	Nearly instantaneous
160°F (71°C)	About 1/2 second
150°F (66°C)	About 1-1/2 seconds
140°F (60°C)	Less than 5 seconds
130°F (54°C)	About 30 seconds
120°F (49°C)	More than 5 minutes

CONDENSATE REMOVAL

The HPWH unit produces condensate which must be discharged. If there is no drain easily accessible, a condensate lift pump must be installed to discharge the condensate to a remote location. See Condensate Drain Line on page 16 for installation instructions.

CONTAMINATED WATER

This HPWH unit must not be used to heat any fluid other than water. Corrosive chemicals must not be introduced into the waterways in this HPWH unit.

⚠ WARNING

Corrosive Chemical Hazard

- Connecting the heat pump to any system other than a water system may lead to premature corrosion of the unit's heat exchanger and void the unit warranty.

TEMPERATURE-PRESSURE RELIEF VALVE

This heat pump water heater should only be connected to a storage tank with a properly rated/sized and certified combination temperature - pressure relief valve. The valve must be certified by a nationally recognized testing laboratory that maintains periodic inspection of production of listed equipment of materials as meeting the requirements for Relief Valves for Hot Water Supply Systems, ANSI Z21.22 • CSA 4.4, and the code requirements of ASME.

When the HPWH unit is connected to a storage tank a temperature and pressure relief valve must be installed in the designated opening for the T&P valve per the storage tank manufacturer's requirements. The T&P valve's Btu/hr rating must be equal to or greater than the total heating input rating of all water heaters connected to the storage tank. If more than one water heating appliance is connected to the storage tank the aggregate total of all heating input ratings

⚠ WARNING

Explosion Hazard

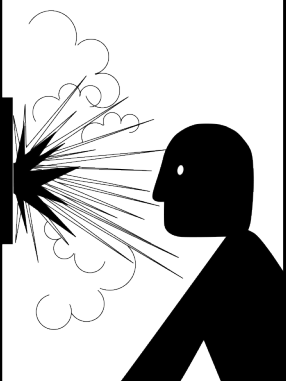

- Temperature-Pressure Relief Valve must comply with ANSI Z21.22- CSA 4.4 and ASME code.
- Properly sized temperature-pressure relief valve must be installed in the designated opening in the storage tank.
- Can result in overheating and excessive tank pressure.
- Can cause serious injury or death.

of all connected appliances must be factored when choosing a T&P valve for the storage tank.

The pressure rating of the T&P valve should always be rated equal to or below the working pressure rating of the storage tank or water heater, whichever rating is lower.

Contact the manufacturer of the storage tank for assistance in sizing of a temperature and pressure relief valve. Follow the storage tank manufacturer's instructions regarding the proper installation of these products.

TANK SELECTION

The HPWH unit is not an instantaneous water heater and must be connected to a storage tank. Storage tank configurations must meet these criteria:

- The HPWH must not be connected directly to a standard gas or electric water heater.
- If the HPWH is connected to a used storage tank, the tank should be thoroughly cleaned of scale and sediment before the HPWH is installed.
- Connection ports used on the storage tank must permit the recommended flow rate through HPWH. The connection ports used on the storage tank must not be smaller than the inlet outlet connection sizes on the HPWH unit. See Table 4 on page 11.
- Water heated by the HPWH should be returned to the tank at a location that is above the level of the tank's cold water inlet and/or the heat pump's inlet source.
- The HPWH unit's inlet and outlet lines to the storage tank should be dedicated. Example: no other line (such as a building re-circulating loop or cold water supply) should be connected to the HPWH unit's inlet or outlet water lines.

SOLAR TANKS

Solar tanks should be used with caution. Some solar tanks with top connections have dip tubes which may significantly reduce the efficiency performance of the HPWH unit.

Before using any solar tank in this application, contact your representative or call the toll free technical support number on the back cover of this manual for further assistance.

CONTAMINATED AIR

The supply (outlet) air from a HPWH installed in a garage or a unit drawing return (inlet) air from a garage or any area where solvents or other chemicals that emit potentially harmful fumes are stored or automobiles are located must never be ducted to any other space inside the building structure. This would include all occupied and unoccupied spaces such as attics or basements. Potentially harmful fumes and vapors could be introduced into occupied spaces. See Unit Placement on page 14.

⚠ WARNING

Breathing Hazard - Carbon Monoxide Gas

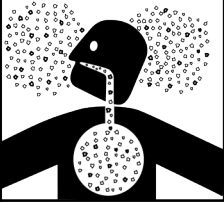

- Do not duct air from a garage or other space where potentially harmful fumes from solvents, chemicals or exhaust from automobiles are present into any other space in the building structure.
- Gas and carbon monoxide detectors are available.

Breathing carbon monoxide can cause brain damage or death. Always read and understand instruction manual.

STORAGE & HANDLING

The heat pump water heaters covered in this manual are stationary refrigeration appliances. Careful handling is necessary to prevent internal damage.

⚠ WARNING

HEAVY OBJECT!

All Heat Pump Water Heaters (HPWHs) covered by this manual are beyond the safe lifting weight for one person. Use proper conveyance equipment to move the unit for storage or during installation. Use OSHA approved safety equipment when moving the unit.

- IMPORTANT:** Do not remove, cover or deface any permanent instructions, wiring diagrams, labels, or the rating label from the outside cabinet or the inside panels on the HPWH unit.
- Do not tilt the unit beyond 45° at any time. All internal components are braced from the base of unit. Tilting may compromise the refrigeration piping inside unit and cause refrigerant leaks.
- Do not hoist the unit with chains or straps unless spreader bars are furnished and used as depicted in Figure 4 and Figure 5. The side panels and roof of the unit are not constructed to handle significant force from the sides or above.
- The HPWH unit is heaviest on the compressor side (left side when facing the front of the unit). See Figure 4 and Figure 6.

- When using a forklift to raise the HPWH unit ensure the forks are positioned correctly between the runners on the bottom of the HPWH unit. See Figure 6.
- The HPWH unit must be lifted from the front side only when using a forklift to raise the unit. See Figure 6.

STORAGE RECOMMENDATIONS

The HPWH units should be stored indoors. Do not stack units or stack other construction materials on the units while in storage.

The HPWH units contain electrical/electronic components and should only be stored in conditions between 0°F to 110°F (-17°C to 43°C) and 5 to 95 percent relative humidity. Electrical components are not moisture-tolerant.

Note: The limited warranty does not cover damage to the unit or controls due to negligence during storage.

The pictures may appear different than your actual unit. all information and reference to lifting applies to all of our models

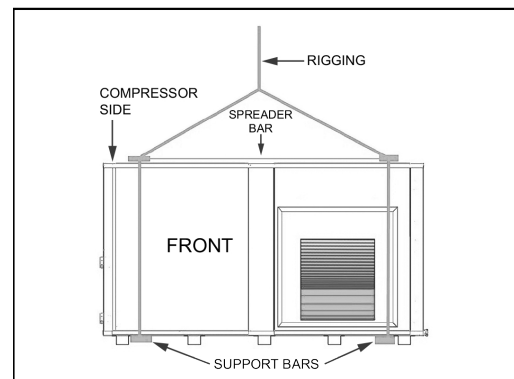

FIGURE 4

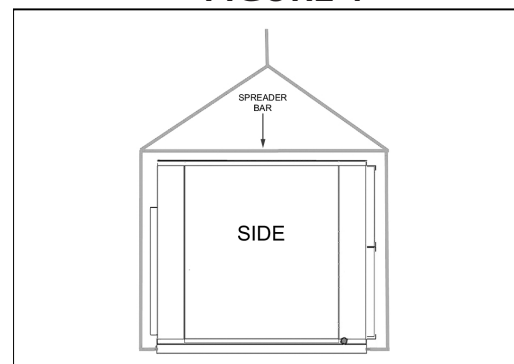

FIGURE 5

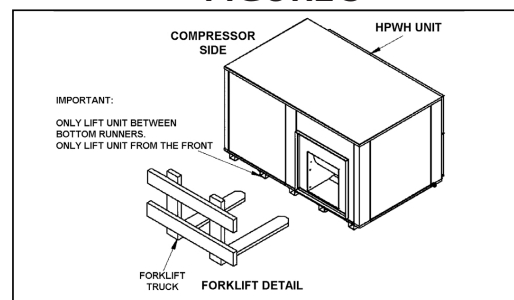

FIGURE 6

INSTALLATION

REQUIRED ABILITY

Installation and service of the HPWH unit requires ability equivalent to that of a qualified agency in the field involved. Plumbing, ducting and electrical work are required. See Qualifications on page 3.

GENERAL

The installation must conform with these instructions and the local code authority having jurisdiction. In the absence of local codes, the installation must comply with the latest editions of the National Electrical Code, ANSI/NFPA 70 or the Canadian Electrical Code CSA C22.1. The National Electrical Code may be ordered from: National Fire Protection Association, 1 Batterymarch Park, Quincy, MA 02269. The Canadian Electrical Code is available from the Canadian Standards Association, 8501 East Pleasant Valley Road, Cleveland, OH 44131.

DO NOT start the HPWH unit or test the electrical system before it is connected to the water system, purged of air and filled with water. See Start Up on page 22.

See Features And Components on page 5 to identify the principal components of the HPWH. (Some units will vary)

REQUIRED TOOLS & MATERIALS

INSTALLATION & START UP TOOLS

1. All tools common to installation and service of commercial electric water heaters such as hand tools, pipe cutter and torch.
2. Heat transfer compound (paste) such as Honeywell part number 107408 or equivalent.
3. Electrical switch lock out device - used to secure disconnect switches/breaker panels while servicing.
4. Electronic thermometer including:
 - Four (4) thermocouple sensors capable of measuring surface temperatures on water or refrigerant piping up to 2 inch diameter.
 - Two (2) thermocouple sensors capable of measuring ambient air temperature.
 - Temperature range 32°F - 210°F (0°C - 100°C).
5. Volt-Ohm Multi Meter - capable of measuring:
 - AC Voltage up to 600 VAC.
 - DC Voltage up to 24 VDC.
 - Ohms up to 2,000,000 ohms.
 - Continuity.
6. AC amp meter - capable of measuring:
 - AC amperage up to 200 amps.
7. Calculator.

SERVICE TOOLS

See Qualifications on page 3 regarding regulations and certifications required under Section 608 of the Clean Air Act before servicing the refrigeration circuit.

1. Refrigeration manifold gauges.
2. Refrigeration charging scale.
3. Refrigeration vacuum pump.
4. Refrigerant recovery machine.
5. Refrigerant reclamation storage tank.

UNIT PLACEMENT

Whether replacing existing water heating equipment or installing the HPWH in new construction, the following critical points must be observed: The HPWH unit:

1. Should be installed near a floor drain for condensate removal.
2. The HPWH, storage tank and water heater(s) should be located in an area where leakage will not result in damage to adjacent area or to lower floors in the building structure.
3. The HPWH unit must be level for proper condensate drainage. Shim the channel type skid base, pad or floor as necessary if leveling is required.
4. Should be installed close to the point of major hot water usage and power supply.
5. Should be located so that hot water piping and branch circuit wiring will be as short as possible.

CEILING SUSPENSION

Because warm air rises, a drop ceiling or suspended from ceiling configuration is preferred to take advantage of higher ambient temperatures. The HPWH may be suspended from the ceiling using a safe and properly designed support. The sides and top of the cabinet are not designed to support the weight of the unit.

Do not attach straps or bars directly to the sides or top of the cabinet. If the HPWH is suspended, it must be supported from underneath.

MOUNTING FRAME

The mounting frame must support the length, width, and weight of the HPWH unit. The weight of the HPWH unit must be evenly dispersed across the footing channels on the bottom of the unit. See Table 1 on page 7 for unit dimensions and weights.

NOTE: A qualified engineer should design and size the structural components of the mounting frame and the appropriate hangers. Structural channels in a field-provided frame should be mounted perpendicular to the unit's footing channels.

The following critical points must be observed when the HPWH unit is suspended from the ceiling:

1. Hanging rods must not obstruct access doors.
2. VIBRATION ISOLATORS ARE REQUIRED to prevent transmission of mechanical vibration into the building structure. Selection of suitable isolators should be made by a qualified engineer.
3. Installation must meet local seismic restraint requirements.

PAD MOUNTING

The HPWH may be pad mounted. Vibration isolator mounts **MUST BE** placed between the unit and the equipment pad to prevent mechanical vibration transmitting into the building structure. Selection of appropriate vibration isolators should be made by a qualified engineer. Unit must be level and elevated at least 6" above floor to avoid dust and debris from entering the unit and permit connection of the condensate trap. See Condensate Drain Line on page 16.

ELECTRICAL CONNECTIONS

CORRECT VOLTAGE AND PHASE

The HPWH units covered by this instruction manual can be ordered with multiple power supply voltage and phase configurations. Ensure the power supply voltage and phase at the job site matches the power supply ratings listed on the HPWH rating label **BEFORE INSTALLATION BEGINS**.

Voltage applied to the HPWH should not vary more than +5% to -10% of the voltage requirement listed on the HPWH rating label for satisfactory operation.

Energizing the HPWH with the wrong voltage and/or phase may cause permanent damage to HPWH components. Damage resulting from applying the wrong power supply voltage or phase to the HPWH is not covered under the limited warranty.

BRANCH CIRCUIT DISCONNECT SWITCH

The power supply wiring and equipment grounding must be installed in accordance with local codes or, in the absence of local codes, the National Electrical Code, ANSI/NFPA 70 or the Canadian Electrical Code, CSA C22.1.

Install an adequately fused disconnect switch as close to the units possible. See unit rating label for maximum fuse size (MFS).

Run the power supply lines from the disconnect to the control box at the side panel of the unit. Connect the lines to the terminals on input side of power distribution block L1 & L2 for single phase and L1, L2 & L3 for three phases. Connect ground wire to ground lug.

TRANSFORMER CONFIGURATION 208 VAC MODELS

C25 & C60 Only

The transformer leads must be changed on units connected to a 208 VAC power supply as described below.

⚠ WARNING	
	Electrical Shock Hazard
	<ul style="list-style-type: none">• Before removing any access panels or servicing the water heater, make sure the electrical supply to the water heater is turned "OFF."• Failure to do this could result in death, serious bodily injury, or property damage.

Turn on power to the HPWH momentarily and measure the voltage to the primary winding of the transformer at the F3 fuse block. If the measured voltage is above 215 VAC no changes are necessary.

If the measured voltage is 215 VAC or less, then the primary leads of the transformer must be changed from the 230 VAC tap to the 208 VAC tap. Do this by disconnecting the orange wire from the transformer primary terminal and replacing with the red wire. Before reapplying power, ensure orange lead is safely isolated with a wire nut and electrical tape.

WATER CONNECTIONS

Water piping must be installed in accordance with the instructions in this manual and all local plumbing codes having jurisdiction. See Figure 7 and Figure 8 on page 16 and the Piping Diagrams on page 34 as a reference for these instructions.

INSTALLATION INSTRUCTIONS

1. This HPWH unit is not designed to supply hot water directly to hot water fixtures. The HPWH unit must be installed with a separate storage tank as shown in the water piping diagrams in this instruction manual.
2. Water lines installed between the storage tank and the HPWH unit **MUST NOT** be less than the water pipe connection sizes on the unit. See Table 4 on page 11.
3. The HPWH should be plumbed directly to the storage tank.
4. The cold water supply must be connected directly to the storage tank at a low connection port on the storage tank on single tank and two tank preheat piping configurations for optimal efficiency. See Figure 7 and Figure 8 on page 16.
5. The cold water supply **MUST NOT** be connected the inlet (entering/return) water line to the HPWH unit.
6. The outlet (supply) water from the HPWH unit should connect to a middle or lower port on the storage tank.
7. The inlet (return) water from the HPWH unit should connect to a port on the storage tank lower than the outlet.
8. A heat trap should be installed between the storage tank and the backup water heater on two tank preheat systems. See Piping Diagram on page 34.
9. A T&P valve must be installed in the designated opening on the storage tank per the tank manufacturer's requirements. See Temperature - Pressure Relief Valve on page 12.

10. For optimal performance minimize the equivalent length of water piping between the HPWH and storage tank.
11. Building hot water recirculation loop should be connected to the inlet of the backup water heater on two tank preheat configurations or to the storage tank on single tank configurations. The recirculating pump **MUST** BE controlled by a field supplied thermostat installed in the building recirculation return line near the storage tank or back up heater. The thermostat should stop pump operation the moment the recirculation line is hot.
12. Use swing-type check valves (not spring-loaded types) on the water outlet lines of all HPWH units plumbed in parallel to prevent hot water short-circuiting.
13. Water lines shared by parallel HPWH units must be large enough to handle combined water flows. Flow rates through the heat pumps and tank(s) must be balanced. See Table 1 on page 8 for HPWH unit flow rates.
14. All components in the hot water supply system must be adequately sized to meet peak water flow requirement
15. When the HPWH unit is installed above the storage tank install a Tee fitting at a high point in the outlet water line leaving the unit. Install a purge valve, or if required by local code, a T&P valve (temperature and pressure relief) in a branch of the Tee fitting that can be used to purge air from the HPWH unit during start up. See Figure 7 and Figure 8.
16. DO NOT install a (T&P) relief valve in the outlet line of the HPWH unit unless required by local code.
17. Dielectric unions should be installed at the inlet and outlet water lines to the HPWH unit.
18. All HPWH water piping must be insulated.

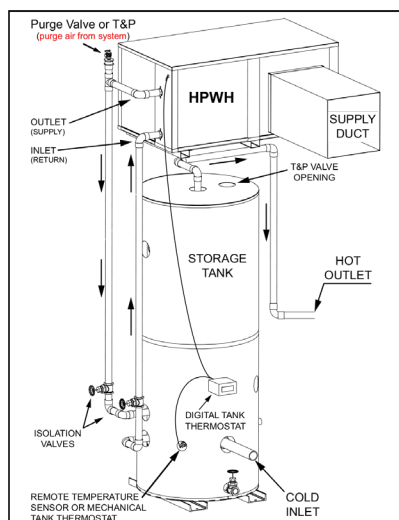

FIGURE 7

SINGLE TANK CONFIGURATION

The HPWH must be plumbed to storage tank. The maximum stored water temperature the HPWH unit can produce in the storage tank is 150°F (66°C). Figure 7 shows a typical storage tank piping configuration. Tank ports must be large enough to handle

the peak water flow rates through the water heating system. See Piping Diagrams on page 34 for detailed piping diagrams.

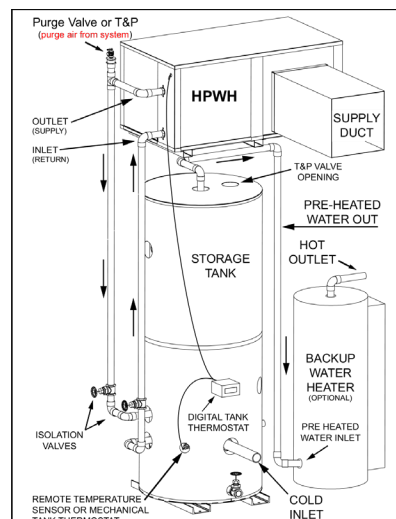

FIGURE 8

MULTIPLE TANK PRE HEAT CONFIGURATION

When water temperatures above 150°F (66°C) are required the HPWH and storage tank are piped in series (upstream) with a backup water heater. See Water Temperature on page 9. The backup water heater will raise the temperature of the preheated water to the final system temperature required. Figure 8 shows a typical preheat piping configuration.

CONDENSATE DRAIN LINE

The HPWH unit must be plumbed to permit condensate drainage. Drain piping connected to the HPWH unit should be a minimum 3/4 inch PVC or equivalent. A condensate trap must be used to overcome the internal vacuum to permit proper drainage. See Figure 9 below for recommended drain trap dimensions.

The condensate must be discharged to a suitable drain. If a drain is inaccessible, use a condensate pump.

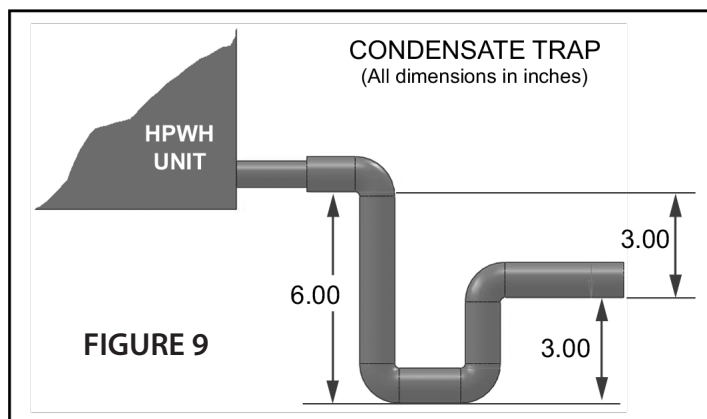

STANDARD TANK THERMOSTAT

Standard tank thermostats (Aquastat) already installed in the storage tank may be used instead of the factory supplied Digital Tank Thermostat if desired. Ensure the standard tank thermostat is installed the lower third of the tank. Wire the existing tank thermostat to the HPWH terminal strip.

TEMPERATURE SENSOR INSTALLATION

The HPWH unit is shipped from the factory with a Digital Tank Thermostat that includes a Temperature Sensor:

1. Secure the Temperature Sensor inside a Sensor or Thermal Well.
2. Install the sensor well in the storage tank's designated temperature control opening. It is not recommended to install the temperature probe or sensor in the bottom or the top of the tank. It is typical to install in the mid to lower portion of the tank.

Do not install the temperature sensor near the cold water supply connection to the storage tank to prevent short cycling.

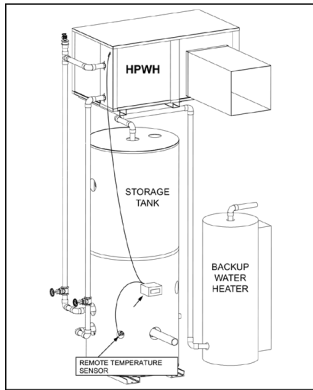
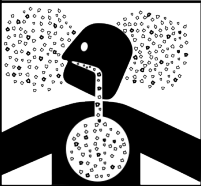

FIGURE 10

AIR FLOW AND DUCTING

GENERAL GUIDELINES

Review Locating The Water Heater on page 8, and this section prior to connecting ductwork to the HPWH. See Features And Components on page 9 to locate components.

⚠ WARNING	
Breathing Hazard - Carbon Monoxide Gas	
	<ul style="list-style-type: none">• Do not duct air from a garage or other space where potentially harmful fumes from solvents, chemicals or exhaust from automobiles are present into any other space in the building structure.• Gas and carbon monoxide detectors are available.
Breathing carbon monoxide can cause brain damage or death. Always read and understand instruction manual.	

The supply (outlet) air from a HPWH installed in a garage or a unit drawing return (inlet) air from a garage or any area where solvents or other chemicals that emit potentially harmful fumes are stored or automobiles are located must never be ducted to any other space inside the building structure. This would include all occupied and unoccupied spaces such as attics or basements. Potentially harmful fumes and vapors could be introduced into occupied spaces. See Unit Placement on page 14.

DUCT SIZING

Supply and return air ducting must be sized properly to insure adequate airflow. Table 6 & Table 7 on page 18 provide

requirements for the total equivalent supply and return duct lengths allowed. These tables are based on the most common duct material options available today. Exceeding those maximum lengths will adversely affect the operation of the heat pump.

DUCT INSULATION

The cooled air from the HPWH may be below room dew point. Insulate the supply duct to prevent dripping from moisture condensing on the duct.

It is not necessary to insulate return ducts unless the air in the return duct is lower than the room air. Also consider insulating all ductwork to reduce blower noise from the unit.

MAKE DUCT CONNECTIONS

Install all ductwork to and from unit in accordance with all applicable codes. Duct construction must allow unit to operate within the limits of the unit external static pressure as in the HPWH unit's performance and specification sheets. See Table 1 on page 7 also.

Use flexible connections to minimize duct-to-duct alignment problems and noise transmission.

Install ductwork, accessory grilles, and plenums so that they do not restrict access to filter and so they prevent dirt, dust, and debris from settling in unit.

DUCTING MULTIPLE UNITS

Nyle recommends not ducting multiple heat pumps together into a common header to avoid external static pressure fighting against the other pieces of equipment. If this is done, the Engineer of Record needs to take extra precautions around this design and assumes responsibility for over-drawing amperage on the motors, blown fuses, and all other air side issues that may arise.

BUILDING AIR PRESSURE

When installing ducting to or from an alternate location (other than the installed space) both the supply (outlet) and return (inlet) air may need to be ducted to prevent positive or negative building air pressure conditions within the installed space.

NEGATIVE PRESSURE

Ducting supply air only to an alternate location, such as the outdoors, may cause excessive negative air pressure inside the building envelope.

Excessive negative pressure inside the building structure may result in cold or hot air from outdoors being drawn inside the building and place additional load on space heating and cooling equipment. Negative air pressure in buildings can also cause reverse flow in chimneys and gas vents.

POSITIVE PRESSURE

Ducting return air only from an alternate location, such as the outdoors, may cause excessive positive air pressure inside the building envelope.

Excessive positive pressure inside the building structure may place additional load on space heating and cooling equipment by interfering with the delivery of conditioned air.

WHEN TO INSTALL DUCTING

HPWH units are often installed in unoccupied spaces or equipment rooms where there is an ample source of ambient heat and no need to redirect the supply air to another location. Ductwork is not necessary in these circumstances. See Heat Source, Conditioned Space, and Unconditioned Space on pages 8 & 9.

Typical applications when ducting is installed.

- Duct supply (outlet) air to alternate location for spot cooling or discard supply air not wanted in the installed space.
- Duct return (inlet) air from an alternate location (outdoors, warm equipment room) to optimize efficiency.

SUPPLY AIR DUCTING

Observe and follow these guidelines and instructions when installing supply (outlet) air duct:

- When duct work is not field connected to the supply air

outlet on the HPWH unit a field supplied safety guard must be installed over the supply air connection. Failure to comply could result in severe injury.

- All ductwork and plenums shall be field supplied or fabricated.
- The total equivalent length of all supply and return air ducting must not exceed the maximum equivalent lengths shown in Table 6 or Table 7.
- Cooling output (supply air) from the HPWH is supplemental only and must not be factored into sizing calculations for space cooling equipment. Cooling output is only produced when the HPWH is operating to satisfy a water heating demand. Once the storage tank temperature is satisfied, the HPWH will stop until the next water heating demand is initiated regardless of space cooling needs.
- Depending on the temperature of the air entering the HPWH unit the supply air may not be suitable for supplemental space cooling purposes.
- The air temperature drops approximately 12°F to 20°F (7°C to 11°C) as it flows through the HPWH unit. If the return air to the HPWH unit is derived from a location

TABLE 6

METAL DUCT			DUCT SIZE (INCHES)									
			6	8	10	12	14	16	18	20	22	24
MODEL	CFM	EXT (in WG)	MAXIMUM EQUIVALENT LENGTH (FEET)									
C25	1,250	0.35	3	14	41	102	208	417				
C60	2,800	0.35		6	17	41	90	173	308			
C90	2,800	0.35		3	10	25	52	105	188	313		
C125	4,500	0.35			6	14	31	59	107	180	292	
C185	4,500	0.35			5	12	26	49	87	148	234	
C250	8,000	0.35			4	9	18	35	64	110	170	262
ELBOW SIZE (IN)			6	8	10	12	14	16	18	20	22	24
EQUIVALENT FEET ONE 90° ELBOW			18	23	29	35	41	47	53	58	64	70

TABLE 7

DUCT CONNECTION SIZES				
UNIT	SUPPLY		RETURN**	
	VERTICAL	HORIZONTAL	VERTICAL	HORIZONTAL
C25	14	14	20.25	27
C60	16	16	24	35
C90	18	18	24	47
C125	22	22	38	49.5
C185	22	22	38	49.5
C250	24	24	38	49.5

**When installing return duct to the unit, a filter access door should be included in the field fabrication.

that is above 80°F (27°C) the supply air from the HPWH unit will not be suitable for offsetting the building cooling load. This will often be the case when the return air is ducted from a warm equipment room or from the outdoor atmosphere. In these circumstances do not duct supply air to another location for spot cooling.

- Ducting supply air only to an alternate location, such as the outdoors, may cause excessive negative air pressure inside the building envelope.
- Provision must be made to prevent a negative pressure in the installed space or building envelope. Return air must be supplied to the HPWH from the alternate location through ducting or louvers that communicate with the alternate location where the supply ducting terminates. See the Return Air Ducting section that follows.

RETURN AIR DUCTING

Observe and follow these guidelines and instructions when installing return (inlet) air duct:

- All ductwork and plenums shall be field supplied or fabricated.
- The total equivalent length of all supply and return air ducting must not exceed the maximum equivalent lengths shown in Table 6 or Table 7.
- When installing return air duct to the HPWH unit a field supplied/fabricated filter access door must be installed.
- Ducting return air only from an alternate location, such as the outdoors, may cause excessive positive air pressure inside the building envelope.
- Provision must be made to prevent a positive pressure in the installed space or building envelope. Supply air must be supplied to the HPWH from the alternate location through ducting that communicates with the alternate location from where the return air is derived. See the preceding Supply Air Ducting section.

BLOWER ASSEMBLY ADJUSTMENTS

DANGER

Sharp Spinning Blades!

The blower operates at a high RPM that can cause injury. To prevent inadvertent access to the blower opening, supply ducting or other suitable means to prevent access must be provided.

The HPWH blower is a belt driven assembly. The blower belt and sheaves are factory pre-set and should not require any field adjustment. The blower assembly should be checked to ensure the blower wheel moves freely and that sufficient tension is on the blower belt. If belt looseness is suspected, check the blower maintenance section of the manual for re-set recommendations.

INSTALLATION CHECKLIST

The list below represents some of the most critical installation requirements that, when overlooked, often result in operational problems, down time and needless parts replacement. This is not a complete list. Before performing any troubleshooting procedures use the list below to check for installation errors. Costs to correct installation errors are not covered under the limited warranty. Ensure all installation requirements and instructions in this manual have been followed.

LOCATION

1. Ensure the HPWH is located where there is a adequate supply of ambient heat for optimal performance or that the HPWH is ducted to such a location.
2. Ensure required clearances are maintained and there is access for servicing. See Clearances on page 9.
3. Ensure the HPWH is properly supported. See Ceiling Suspension and Pad Mounting on pages 14 & 15.

AIR FLOW & DUCTING

4. Ensure all supply and return ductwork connected to the HPWH is properly sized, does not exceed maximum equivalent length requirements and is installed according to the instructions in this manual. See Air Flow and Ducting on page 17.
5. Ensure all supply duct work is insulated to prevent condensation from forming on the ductwork.
6. Ensure all return air duct is insulated if the return air temperatures are expected to fall below the surrounding room air temperature during normal operation.

WATER PIPING

7. Ensure the outlet (supply) and inlet (return) water piping connected to the HPWH are not less than the connection size on the unit. See Table 1 on page 7.
8. Ensure swing-type check valves (not spring-loaded types) are installed on outlet lines of all heat pumps plumbed in parallel to prevent hot water short-circuiting.
9. When the HPWH is connected to a storage tank ensure the storage tank is equipped with a properly rated and sized Temperature and Pressure (T&P) relief valve. Refer to the storage tank manufacturer's instructions for T&P valve sizing and installation requirements.

Note: This is a critical installation requirement that must not be overlooked. Call the toll free technical support phone number at the back of this manual for further assistance.

10. DO NOT install a T&P valve in the outlet (supply) water line of the HPWH unless required by local code.
11. Ensure isolation valves are installed on the HPWH supply and return water line at the storage tank for servicing and purging the air from the HPWH during start-up.

12. Ensure the cold water supply is not connected directly to or Tee fitted to the inlet water line on the HPWH. See the Service and Installation Notes for Inlet & Outlet Water Temperature on page 8. See Figure 7 and Figure 8 on page 16.
13. Connect building recirculation loop piping to the backup water heater inlet on two tank preheat piping configurations.
14. Ensure the building recirculation loop pump is controlled by a field supplied line thermostat and that it stops the pump when the recirculation line temp exceeds the manufacturer's specifications.
15. When the HPWH unit is installed above the storage tank install a Tee fitting at a high point in the outlet water line with a purge valve to bleed air during start up.
16. The manufacturer recommends installing a strainer at the inlet water line on the HPWH to help prevent scale build up in the heat exchanger. Service costs to clear blockages from the HPWH unit's heat exchanger due to debris are not covered under the limited warranty.
25. Ensure all electrical connections in the HPWH control panel are securely tightened.
26. When the factory supplied Temperature sensor is used:
 - Insure the sensor is installed properly.
 - Ensure the Temperature Sensor has been installed in a designated temperature control opening in the mid/lower portion of the storage tank.
 - Ensure the supplied Temperature Sensor is coated with a suitable heat transfer compound (paste).

CONDENSATE DRAIN

17. Ensure there is a water trap installed in the condensate line at the HPWH. Condensate will not drain without a water trap.
18. Ensure the condensate drain is properly connected to the HPWH and draining freely to a suitable floor drain or condensate lift pump that discharges condensate to a remote location. See Condensate Drain Line on page 16.

ELECTRICAL

19. BEFORE ENERGIZING THE UNIT ensure the power supply voltage and phase matches the requirements on the HPWH rating label. Damage resulting from applying the wrong voltage or phase is not covered under the limited warranty.
20. On HPWH units connected to 208 VAC power supplies ensure the transformer has been properly configured. Damage caused by failure to configure the transformer properly is not covered under the limited warranty. See Transformer Configuration 208 VAC Models on page 15.
21. Ensure the power supply breaker or the fuses disconnect switch are within the requirements for the unit as shown on the HPWH rating label.
22. Ensure the power supply wiring meets the MCA (Minimum Circuit Ampacity) requirements shown in this manual and on the HPWH data label.
23. Ensure the HPWH is properly grounded according to the instructions in this manual and local code requirements.
24. Ensure the power supply connections to the HPWH are connected properly and securely tightened.

PRE-STARTUP CHECKLIST

1. Before applying power, check all electrical connections. Tighten if necessary.
2. Verify electrical installation. Power requirements and branch circuit disconnecting means match equipment nameplate specifications.
3. Make sure the hydronic system is flushed and purged of air. Remove and clean any strainers or filters if necessary.
4. Make sure the sensor for the temperature control is mounted to either the water tank or strapped to a water line for proper temperature control.
5. Remove the shipping blocks from under the compressor. Loosen the nuts on the spring mounting studs and pry up one side of the compressor at a time and remove. Leave the nuts loose on the spring mounting studs.
6. Power up, (if field supplied), external circulator pump and verify water flow through the heat pump's heat exchanger.
7. Turn on power to the heat pump. Confirm power with an electrical meter. Check for proper control power, should be between 120 to 125 volts.

***Note: The power should be on for 6 hours so the compressor crankcase heater has time to warm up the base of the compressor.**
8. Start the heat pump by pressing the Start key on the Touchscreen. Monitor the refrigerant pressure, hot water in and out temperatures, and cold water in and out temperatures.
9. There are Fan, (or Blower, if so equipped), Direction stickers, mounted on each unit.

It may be helpful to record the operating data initially every 10 to 15 minutes just to see how the heat pump is performing.

3 PHASE STARTUP PROCEDURES

- Make sure the disconnect is off and confirm there is no power on the distribution block on the electrical panel.
- Pull Compressor fuses.
- Trip the blower/fan motor starter.

- Turn power on. Check and make sure the power at the distribution block is the same as the power requirements on the data sticker that is on the electrical panel.
- Put an amp meter on one of the legs for the blower/fan motor. Confirm the amperage is in line with the data sticker.
- Reset the manual motor starter for the blower/fan.
- Make sure the blower/fan is going in the correct direction. (Should be blowing air at you when your standing in front of it)
- If it is going the wrong direction, then you need to switch the phases. You will need to switch two of the legs that you supplied to the distribution block. The rotation on the blower/fan is rotating the same direction of the compressor, that was set at the factory. So, if the blower/fan is operating in the correct direction then your compressor will be as well. Make sure to turn the power off before switching the phase. Confirm there is no power with an electrical meter then make the switch. Turn the blower/fan motor start off and then turn the power back on. Check for power and then pull in the blower/fan motor starter back on and record the amperage. Confirm the rotation is correct.
- The factory temp setting is 120°F. If you would like to change the temperature, then now is the time. (It can be done later as well, **NEVER SET HIGHER THAN 160°F**).
- Turn power off.
- Double check to make sure all the air is out of the water line so the heat pump doesn't get air bound.
- Pump Test – With the compressor fuses pulled and the blower/fan motor starter in the off, (tripped), position. Turn the power back on. See figure #1, Press the orange by-pass button on the pump relay to operate the water pump. You should be able to hear the water flowing through the system. If not, there is a good chance the system is air bound and the air needs to be removed before starting the compressor. Turn power back off after test.
- Install compressor fuses and turn the blower/fan motor starter back on.
- Turn power back on and the heat pump will start within 5 minutes if there is a call for heating.
- Once the compressor starts, make sure to record the amperage and that is doesn't exceed the amperage on the data sticker.
- Measure the temperature on the water in and water out lines. After the unit has been running for 15 minutes, there should be a temp rise of 5°F or more.
- Confirm the Flow rate on the water side is correct (see manual for flow rates)

FIGURE #1



SINGLE PHASE STARTUP PROCEDURES

- Make sure the disconnect is off and confirm there is no power on the distribution block on the electrical panel.
Warning: Single phase systems have capacitors. You should wait 5 minutes after turning the power off to service it. Capacitors can hold a charge even when the power is off.
- Pull Compressor fuses.
- Trip the blower/fan motor starter.
- Turn power on.
- Check and make sure the power at the distribution block is the same as the power requirements on the data sticker that is on the electrical panel.
- Put an amp meter on one of the legs for the blower/fan motor. Confirm the amperage is in line with the data sticker.
- Reset the manual motor starter for the blower/fan.
- The factory temp setting is 120°F. If you would like to change the temp, then now is the time. (It can be done later as well, **NEVER SET HIGHER THAN 160°F**).
- Turn power off.
- Double check to make sure all the air is out of the water line so the heat pump doesn't get air bound.
- Pump Test – With the compressor fuses pulled and the blower/fan motor starter in the off (tripped) position. Turn the power back on. See figure #1. Press the orange by-pass button on the pump relay to operate the water pump.
- You should be able to hear the water flowing through the system. If not, there is a good chance the system is air bound and the air needs to be removed before starting the compressor.
- Turn power back on and the heat pump will start within 5 minutes if there is a call for heating.
- Once the compressor starts make sure to record the amperage and that is doesn't exceed the amperage on the data sticker.
- Measure the temp on the water in and water out lines. After the unit has been running for 15 minutes, there should be a temp rise of 5°F or more.
- Confirm the Flow rate on the water side is correct (see manual for flow rates)

INITIAL START-UP

CAUTION OIL DILUTION! Bearing malfunction! It is important to ensure that new compressors are not subjected to liquid abuse. Turn the crankcase heater on 4 - 6 hours before starting the compressor. CAUTION High discharge pressure operation! Compressor damage! Do not use compressor to test opening set point of high-pressure cutout. Bearings are susceptible to damage before they have had several hours of normal running. Liquid and high pressure loads could be detrimental to new bearings. It is therefore important to ensure that new compressors are not subjected to liquid abuse and high-pressure run tests. It is not good practice to use the compressor to test the high-pressure switch function on the production line. Switch function can be tested with nitrogen prior to installation and wiring can be checked by disconnecting the high-pressure switch during the run test.

MASTER CONTROL PANEL PRE-STARTUP

1. Mount the master control panel close to the Heat Pump Water Heaters, tank(s), and to a 120/1/60 power source.
2. Remove the control fuse in and connect the Master Control Panel to the 120/1/60 power source, the incoming power terminations are labeled.
3. Run an Ethernet cable between the Master Control Panel's switch and each Heat Pump Water Heater. You will need to make these cables on site and feed them through the marked connection points. Refer to the electrical diagram for connection information.
4. IMPORTANT: The Master Control Panel in any multi-unit configuration will have the only temperature probe. (units working individually will not use a Master Control Panel and will each have their own tank temperature probe) Install the tank temperature probe in a designated temperature control opening in the mid/lower portion of the storage tank. Use a suitable heat transfer compound on the probe to ensure an accurate temperature reading.
5. If desired connect the Building Management System to the Master Control Panel using the protocol determined at the time of purchase. (we offer TCP and MSTP but this MUST be determined prior to building the panel)
6. Insert the control fuse and power up the Master Control Panel. Check the voltage into the terminal block and make sure that it is 120V.
7. Reference page 30 for instructions on how to set up the I.P. addresses for the Master Control Panel.

ROTATION DIRECTION

Scroll compressors, like several other types of compressors, will only compress in one rotational direction. Direction of rotation is not an issue with single-phase compressors since they will always start and run in the proper direction. Three-phase compressors will rotate in either direction depending upon

phasing of the power to L1, L2 and L3. Since there is a 50/50 chance of connecting power in such a way as to cause rotation in the reverse direction, it is important to include notices and instructions in appropriate locations on the equipment to ensure proper rotation direction is achieved when the system is installed and operated. Observing that suction pressure drops and discharge pressure rises when the compressor is energized allows verification of proper rotation direction. There is no negative impact on durability caused by operating three-phase Copeland Scroll™ compressors in the reversed direction for a short period of time, (under one hour), but oil may be lost. Oil loss can be prevented during reverse rotation if the tubing is routed at least 15 cm above the compressor.

After several minutes of operation in reverse, the compressor protection system will trip due to high motor temperature. The operator will notice a lack of cooling. However, if allowed to repeatedly restart and run in reverse without correcting the situation, the compressor will be permanently damaged. All three-phase Scroll compressors are identically wired internally.

Therefore, once the correct phasing is determined for a specific system or installation, connecting properly phased power leads to the identified compressor terminals will ensure proper rotation direction. Compressors ZB56K* to ZB220K*, ZS56K* to ZS11M* and ZF24K* to ZF48K* have an electronic protection unit (INT69SCY2) that will not let the compressor operate if the phasing of the wires is incorrect.

STARTING SOUND

During the very brief start-up, a clicking sound is audible, resulting from initial contacting of the spirals and is normal. No start assist devices are required for single-phase compressors, even if a system uses non-bleed expansion valves. Due to the design of the Copeland Scroll, the internal compression components always start unloaded even if system pressures are not balanced. In addition, since internal compressor pressures are always balanced at start-up, low voltage starting characteristics are excellent for Copeland Scroll™ compressors. Moreover, if low voltage conditions exist at start up, protector trips could result.

START UP

This start-up refers to several tools and test instruments needed to complete the procedure. See Required Tools and Materials on page 14.

1. Ensure the Installation Checklist has been completed.
2. Ensure the HPWH, storage tank and water system has been purged of air and all valves are in the position for normal operation.
3. Turn on power at the circuit breaker or disconnect switch serving the HPWH.

If the HPWH does not start immediately:

- Wait 5 minutes in case the anti short cycle timer has halted operation. This control system feature protects

the HPWH from rapid short cycling that can cause permanent damage to the unit.

- Ensure the operating set point on the tank temperature control is adjusted high enough to initiate a call for heat. The recommended setting is 120°F to 150°F (29°C to 66°C).
 - DO NOT set the operating set point on the tank temperature control above 150°F. See Water Temperature Range on page 4.
 - Ensure the Differential Set Point is not set too high. Higher differential settings will cause greater temperature swings in system temperature. Lower differential settings can cause unit short cycling. The recommended setting is 10°F.
 - If the unit does not start after all of the above procedures have been followed. Refer to the troubleshooting section of this manual.
4. Securely attach surface mount thermometers or temperature sensors to the inlet (entering) and outlet (leaving) water lines near the HPWH cabinet. If there are thermometers installed in the inlet and outlet in close proximity to the HPWH water connections they can be used for the following check. Ensure the water outlet (supply) and inlet (return) valves are fully open. Start the HPWH and allow it to operate for 5 minutes. with the HPWH operating record the inlet and outlet temperatures.

During normal operation, the outlet line should be 8°F to 12°F (4°C to 7°C) hotter than the inlet line. This is the temperature rise through the heat exchanger inside the HPWH unit. Note: Temperature rise and water flow rate through the heat exchanger inside the HPWH are uniformly linked. As water flow is decreased the temperature rise will increase and as water flow is increased the temperature rise will decrease. Because of this relationship between temperature rise and flow rate this test can be useful to determine if the flow rate through the heat exchanger is adequate. Other factors may also affect water flow rate and temperature rise such as debris or lime scale build up inside heat exchanger or water pump operation.

If the temperature rise through the HPWH is consistently lower than 8°F the outlet (supply) valve can be throttled slightly closed to reduce the water flow rate. This may be necessary on installations with a minimum of water piping between the HPWH and the water system or tank.

Throttling should be done in small increments, no more than 1/8 turn of the valve handle at a time. The HPWH must be allowed to run for approximately 5 minutes between each adjustment before the temperature rise is measured again. If the outlet valve is throttled during start up, mark the valve position and remove the valve handle to ensure it is not accidentally changed.

If the temperature rise through the HPWH is consistently greater than 12°F the water flow may be restricted. Ensure

all water valves between the HPWH and the tank or water system are fully open. Ensure the external water pump is running. If the temperature rise continues to be excessive call the toll free technical support phone number: **1-800-777-6953 ext. 208**

5. Using thermometers or temperature sensors, measure the temperature of the return (inlet) air to the HPWH and the supply (outlet) air leaving the unit. The outlet air temperature should be 12°F to 20°F (7°C to 11°C) cooler than the inlet air. Air temperature and flow rate through the heat pump determines what this temperature difference will be. The higher the flow rate the lower the temperature differential will be. The higher the air temperature, the higher the differential will be.

If the temperature differential between return and supply air is not within the range stated above ensure the air filters are clean and there is nothing blocking the air flow on either side of the air stream or ductwork attached to the HPWH. Ensure the ductwork is not smaller than the minimum required size and or longer than the maximum length allowed in the Air Flow & Ducting section of this manual. Ensure the evaporator coil is not damaged (fins flattened) or dirty. If the temperature differential continues to be outside the range mentioned above call the toll free technical support phone number on the back cover of this manual for further assistance.

6. When all of the above procedures are complete adjust the tank temperature control set point to desired system temperature, not to exceed 150°F (66°C). Remove all test instruments and replace all cabinet door

SETTING LOWER LIMIT CONTROL VALVE LIMIT FOR SINGLE-PASS

GOAL: Achieve a 3-4 GPM flow rate through the condenser by using the lower limit input.

WHY: Every piping system is different therefore they have different head losses in the system. In order for the Nyle heat pump to operate efficiently and meet the supply demands effectively it is important to set the lower limit of the control valve to meet the minimum water flow rate requirements for the heat pump. The optimal flow rate is 3-4 GPM which allows the unit to sense that there is flow, while also maintaining a high change in temperature between the entering and leaving water. It is strongly advised to write down the control valve lower limit for this system in the case that the system must be purged again.

HOW:

1. Access the configuration screen on the heat pump hot water heater
2. Input a lower limit value between 20 and 100
3. Press purge & wait 30 seconds for flow in the system to become consistent

4. Observe if the goal of 3-4GPM has been met (this value will fluctuate slightly on the screen)
 - A. If the GPM is too high reduce the lower limit value
 - B. If the GPM is too low increase the lower limit value
5. Repeat this process until the goal of 3-4GPM has been achieved.

Lower Limit Value: _____

PURGING THE CONDENSER ON A PLC WATER HEATER

Access the configuration screen on the heat pump hot water heater. Set the "lower limit" value to 100 to open the control valve all the way, then press the purge button to run the pump. (The pump will remain running for 2 minutes unless the button is pressed again to stop the purge cycle) While the pump is running bleed any air out of the water lines. The "CondFlow" value will reflect the flow rate through the condenser of the unit, the default value is 2 so when it is constantly above 2 the unit is flowing properly.

ELECTRONIC TEMPERATURE CONTROLS

The unit comes standard with a Johnson Controls A421 Model # A421GBF-x controller. This control is used to control the water temperature in the tank by supplying a call signal to the Heat Pump Water Heater. The control comes with some factory settings. **The A421 control should never be set higher than 160°F, failure to comply could void the warranty.**



Johnson Controls A421 Controller
Model # A421GBF-x

Notice: Please make sure you are running a Johnson controller (pictured above) before you continue to the next page. If you are running a PLC (Programmable Logic Controller) skip to the directions starting on page 26.

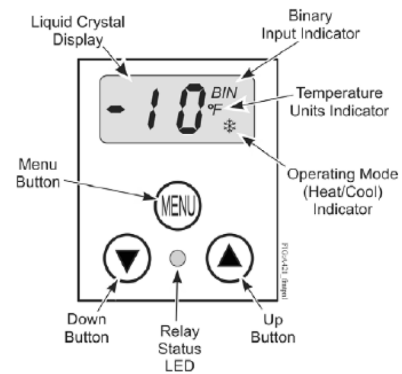

FUNCTION RANGES & SETTINGS

Some of the A421 controllers settings are preprogrammed by Nyle before shipment. These settings along with parameter ranges have been provided for your reference in the Parameter Settings table below.

PARAMETER SETTINGS		
FUNCTION	RANGE	FACTORY SETTINGS
OFF: Desired Temp Hi	-40 to 212 °F -40 to 100 °C	120°F
On: Desired Temp Low	-40 to 212 °F -40 to 100 °C	30°F
ASd: Anti-short Cycle Delay	0 - 12 Min	0 min
SF: Sensor Failure	0= Output De-energized 1= Output Energized	0
bLL: Back light Level	0 = off 1-10 = on, varying brightness	10
ADVANCED PARAMETER SETTINGS		
Un: Temp. Units	°F and °C	°F
tSb: Temp. Setback	-50 to 50°F -30 to 30°C	0°F
So: Sensor Offset	-5 to 5°F -3 to 3°C	0°F
HtS: High Temp. Stop	-40°F -212°F -40°C - 100°C	120°F
LtS: Low Temp. Stop	-40°F -212°F (-40°C - 100°C)	40°F

SCREEN NAVIGATION

The A421 control buttons and display operate the same in both Basic and Advanced mode.

- When in Menu screens the parameters and values will flash on and off.
- Use the Arrow keys to navigate through all of the parameters and values
- To select a parameter press MENU
- To save a selected value, press MENU.
- This will automatically bring you to the next settable parameter
- To exit menus and return to the main screen press both arrow keys simultaneously.

Note: If you do not press MENU to save a new value, the control reverts to the last saved value.

After 30 seconds of inactivity, while in any screen, the control reverts to the Main screen.

Saved settings remain in the control's memory during power interruptions.

BASIC MODE

In this mode you can adjust the OFF, On, SF and ASd Parameters ONLY. Most adjustments that are needed to run your unit will be performed in this mode.

Basic Mode Menu: From the main screen press MENU once. The screen will display the flashing OFF parameter indicating that you have entered the menu.

OFF: This parameter indicates your desired high temperature. When this temp is reached the unit will enter a cool down mode until the On value is reached. **WARNING:** Never set above 160°F.

ON: This parameter indicates your desired low temperature. When this temperature is reached the unit will enter heating mode until it reaches the OFF value again.

ASd: The Anti-Short Cycle Delay indicates the time required for the unit to wait before running again. This parameter is set to 0 min because Nyle units come equipped with safety timers already in place.

SF: Sensor Failure indicates that the temperature sensor has failed.

bLL: Black Light Level indicates the brightness of the LCD screen.

ADVANCED MODE

In Advanced mode you can adjust all of the basic parameters as well as; Un, Tsb, So, HtS and LtS. The main function of this mode is to add more control over your unit and to set restrictions for parameters in basic mode.

Advanced Mode Menu: From the main screen press and hold both arrow keys simultaneously. The screen will display the flashing Un parameter to indicate that you have entered the menu.

Un: Indicates the temperature units. This can be in either Fahrenheit (°F) or Celsius (°C).

LtS: Low Temp. Stop indicates the lowest temperature that the On or OFF parameters can be set to in Basic Mode.

HtS: High Temp. Stop indicates the highest temperature that the On or OFF parameters can be set to in Basic Mode.

tSb: Temp Setback indicates the value for setting back the On and OFF temperature values. Default to 0°F because it is not applicable to the application of this unit type.

So: Sensor Offset allows for compensation of any difference between the displayed temperature and the temperature being read by the sensor.

RESTRICTED MODE

Switching the Controller to Restricted Mode will prevent users from adjusting most or all of the parameter settings. The main screen will function normally.

Note: The OFF parameter is the only parameter that can be accessed in Restricted Mode. So be sure that your desired parameter values are set before changing over to restricted mode.

In addition, the differential between the OFF/ON parameters is fixed in restricted mode. If the OFF parameter is adjusted the On parameter will adjust to maintain the differential.

Setting the controller to restricted mode:

- Turn power off from the controller
- Carefully remove the front panel
- Locate the jumper and carefully position it on one pin as shown in the diagram below.

The controller is now in restricted mode. Securely replace the cover before reconnecting power to the controller.

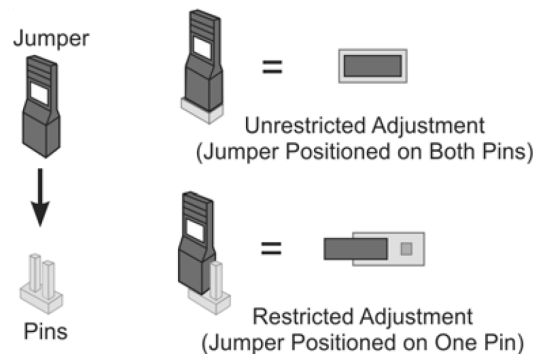

Lock out

You can format your parameters to completely restrict all user adjustment of the control when in restricted mode. To do this set the HtS value equal to the OFF value and the LtS equal to the On value. This makes the OFF/On range equal to the HtS/LtS range and thereby unadjustable in restricted mode.

PROGRAMMABLE LOGIC CONTROLS

PLC CONTROLLER

Your unit may be equipped with a Programmable Logic Controller (PLC) and Human-Machine Interface (HMI) for controlling the water heating process. Sensors within the system provide operating information to the PLC which uses this information to safely control the heating process. The control comes with a pre-set water high temperature setpoint of 120°F. The control is limited to a maximum water high temperature setpoint of 160°F. Operating at higher temperatures could void the warranty.

TEMPERATURE & SETPOINTS

To view and adjust the temperature setpoint, follow these steps.

- View the HMI mounted on the electrical panel door. Locate the “High Temp” value on the setup screen.
- Touch the box representing the current value. A keypad and cursor will appear.
- Enter the desired temperature setpoint (maximum 160°F)
- Touch the return, or enter key on the keypad. The display will return to the info screen, and your entered value should be displayed in the “high Temp” value box. The unit is now set to heat up to the new setpoint temperature.

Note: Until the Return key is pressed, the unit will run based upon the previous setpoint temperature.

Setpoint Ranges & Safeties		
Safety	Factory Setting	Action
Low Flow (heating /cooling side)	< 4.4 Gal/Min	Shutoff
Evaporator Temperature Defrost Cut-In	34° F	Shutoff
Evaporator Temperature Defrost Cut-Out	38° F	Alarm
Temperature Set-point Range	100° F - 160° F	-
High Refrigerant Pressure Cut-Out	410 PSI	Shutoff / Alarm
High Refrigerant Pressure Cut-in	300 PSI	-
Low Refrigerant Pressure Cut-Out	12 PSI	Shutoff / Alarm
Low Refrigerant Pressure Cut-In	15 PSI	-
Compressor Anti-Short Cycle Delay	300 Sec	-

MASTER SCREENS

MASTER PANEL HOME SCREEN

Heat Pump 1: LP 40 psi, HP 243 psi, LLSV Open, Comp On, EvapFlow True, CondFlow True, Cond 124 °F, Evap1 58 °F, Evap2 60 °F, CTD 0, PTD 0

Heat Pump 2: LP 39 psi, HP 240 psi, LLSV Open, Comp On, EvapFlow True, CondFlow True, Cond 123 °F, Evap1 60 °F, Evap2 61 °F, CTD 0, PTD 0

Heat Pump 3: LP 43 psi, HP 238 psi, LLSV Open, Comp On, EvapFlow True, CondFlow True, Cond 122 °F, Evap1 59 °F, Evap2 60 °F, CTD 0, PTD 0

Heat Pump 4: LP 45 psi, HP 242 psi, LLSV Open, Comp On, EvapFlow True, CondFlow True, Cond 124 °F, Evap1 61 °F, Evap2 61 °F, CTD 0, PTD 0

Heat Pump 5: LP 38 psi, HP 240 psi, LLSV Open, Comp On, EvapFlow True, CondFlow True, Cond 123 °F, Evap1 60 °F, Evap2 62 °F, CTD 0, PTD 0

TempAvg: 123.8 °F, TempSet: 150 °F

Tank 1: 124.0 °F, Tank 2: 124.2 °F, Tank 3: 123.8 °F, Tank 4: 123.3 °F

MASTER PANEL ALARM SCREEN

18 Alarm Indicators: HIGH PRESSURE 1-6, LOW PRESSURE 1-6, COND FLOW 1-6, EVAP FLOW 1 / BLOWER 1-6, M PROTECTION 1-6, OIL PRESSURE 1-6

TANK1 PROBE STATUS: 123.4 °F

TANK2 PROBE STATUS: [Red]

TANK3 PROBE STATUS: [Red]

TANK4 PROBE STATUS: [Red]

Buttons: STOP, HOME

MASTER PANEL CONFIGURATION SCREEN

Comp HRS 1: 0 HRS, Comp HRS 2: 0 HRS

Tank Diff Set: 1 °F, System Timer: 300s, TempDiff: 15 °F

Master IP Address: 192, 168, 1, 68

Master IP Subnet: 255, 255, 255, 0

Master IP Gateway: 192, 168, 1, 1

Buttons: SAVE, SEARCH FOR UNITS, HOME, STOP

MASTER SCREEN TERMINOLOGY

HOME SCREEN

“LP” – Low Pressure: indicates the suction line pressure on the low side of the system

“HP” – High Pressure: indicates the discharge line pressure on the high side of the system

“LLSV” – Liquid Line Solenoid Valve: indicates the position of the LLSV (open or closed)

“Comp” – Compressor: indicates the status of the compressor (on or off) **“EvapFlow”** – Evaporator Flow: indicates if the blower is on (Air to Water HPWH) OR if there is water flowing through the evaporator (Water to Water HPWH)

“CondFlow” – Condenser Flow: indicates if there is water flowing through the condenser

“Cond” – Condenser Temperature: indicates the leaving water temperature from the condenser

“Evap1” – Evaporator 1: indicates the evaporator temperature of the first evaporator

“CTD” – Compressor Time Delay: indicates remaining time in compressor delay countdown

“PTD” – Pump Time Delay: indicates remaining time in pump countdown, when the count down starts the pump turns on

Indicator Box – indicates if the unit has been called to run (green means run, red means on standby)

Heat Call – indicates if the master is calling units to run to meet building demand (green means run, red means on standby)

“TempAvg” – Tank Temperature Average: indicates the average current tank temperature which comes from all of the valid connected temperature probes averaged together

“TempSet” – Tank Temperature Setpoint: indicates the desired tank temperature to be maintained

ALARM SCREEN

“HIGH PRESSURE 1” – indicates if unit 1 has alarmed out on high pressure

“LOW PRESSURE 1” – indicates if unit 1 has alarmed out on low pressure

“COND FLOW 1” – indicates if unit 1 has alarmed out on condenser water flow

“EVAP FLOW 1 / BLOWER 1” – indicates if unit 1 has alarmed out on evaporator flow

“M PROTECTION 1” – indicates if unit 1 has alarmed out on motor protection

“OIL PRESSURE 1” – indicates if unit 1 has alarmed out on oil pressure **“ESTOP”** – indicates if the Estop has been pressed

“TANK1 PROBE STATUS” – indicates if tank 1’s probe is connected and reading valid data

CONFIGURATION SCREEN

“Comp HRS” – Compressor Hours: indicates the compressor run time hours of each unit

“Pump %” - Percentage of envelope sent to pump via communication connection.

“Pump Staging” - Percentage of pump envelope called depending on how many heat pumps are running.

“Pump Testing” - Used to hold system at a specific % for setting Pump Staging values.

“Tank Diff Set” – Tank Differential Setpoint: sets the minimum tank temperature rise required to avoid calling another unit

“System Timer” – System Timer: sets the maximum time that the tank has to achieve the Tank Diff Set value to avoid calling another unit

“TempDiff” – Temperature Difference: sets the difference below the setpoint where the master will give a call for members to run

“SAVE”button – Saves the “Tank Diff Set”and “System Timer” parameters

“Master IP Address” – IP Address used to connect panel to BMS system

“Master IP Subnet” – subnet mask for address range IP is configured in

“Master IP Gateway” – IP Address for internet router on site used to connect to unit via VPN

MASTER CONTROL PANEL SETUP TO MEMBER UNITS

1. Hardwire all member units to individual power sources rated for the equipment with disconnects
2. Hardwire the “Master Control Panel” to a 120V power supply through the junction box
3. Hardwire each temperature probe into the junction box for the Master Control Panel and then permanently attach them to their respective tanks
4. Connect all of the member units to the router in the junction box
5. Under the configuration screen press the “SEARCH FOR UNITS” button to find all of the connected members (give the master controls 2 minutes to find all of the member units)

MASTER CONTROL UNIT CALL SEQUENCE OF OPERATIONS

1. Set the “Tank Diff Set” value to 1°F and the “System Timer” value to 300s (5min), then press save to update the program
2. Once the master panel determines that there needs to be a heat call it will determine the unit call order based on;

compressor run hours, alarm status, and unit number. Then the master will call the unit in the first unit in the run order to turn on

- If the tank temperature does not increase 1°F in 300 seconds than the second unit in the run order will be called to run
- The master controls will keep reevaluating these conditions and calling units as necessary to achieve the desired rise in the desired amount of time
- If you find that the units are not turning on fast enough to meet building demand change the "System Timer" to a smaller value in order to have units turn on quicker
- If you find that too many units are turning on and meeting the building demand very quickly (almost in a manner of short cycling) you should try increasing the "Tank Diff Set" value so that additional units will only turn on as needed

MEMBER SCREENS

SINGLE UNIT HOME SCREEN OPERATING WITH MASTER CONTROLS

SYSTEM ON

LP	19 psi	TempSet	150 °F	Evap1	32 °F
HP	149 psi	Cond Flow	0.0 GPM	ENV	Standby
LLSV	Closed	Cond	149 °F	SH	19.0 °F
Comp	Off	SLT	62 °F	CTD	300
Blower	True	Tank	62 °F	PTD	0

CONF REMOTE MODE 

SINGLE UNIT HOME SCREEN OPERATING AS A SINGLE UNIT (IN DEFROST)

SYSTEM ON
Defrost

LP	19 psi	TempSet	150 °F	Evap1	32 °F
HP	149 psi	Cond Flow	0.0 GPM	ENV	Standby
LLSV	Closed	Cond	149 °F	SH	19.0 °F
Comp	Off	SLT	62 °F	CTD	300
Blower	True	Tank	62 °F	PTD	0

HOME STOP START

SINGLE UNIT HOME SCREEN DISPLAYING ALARM

SYSTEM ON







ALARM

LP	19 psi	TempSet	150 °F	Evap1	32 °F
HP	149 psi	Cond Flow	0.0 GPM	ENV	Standby
LLSV	Closed	Cond	149 °F	SH	19.0 °F
Comp	Off	SLT	62 °F	CTD	300
Blower	True	Tank	62 °F	PTD	0

HOME STOP START

SINGLE UNIT ALARM SCREEN

SYSTEM ON

 HIGH PRESSURE	 OUTLET FLOW	 M PROTECTION
 LOW PRESSURE	 EVAP FLOW	 OUT OF ENV

HOME STOP START

SINGLE UNIT CONFIGURATION SCREEN

SYSTEM ON

Diff Timer:	60s	CondFlow	6 GPM
Max Tank Increase:	1 °F	Low Limit	2.0
Min Tank Increase:	1 °F	TANK	PURGE OFF
Temperature Diff:	10 °F		
Compressor Hours:	19 HRS		

HOME STOP START

MEMBER SCREEN TERMINOLOGY

HOME SCREEN

“LP” – Low Pressure: indicates the suction line pressure on the low side of the system

“HP” – High Pressure: indicates the discharge line pressure on the high side of the system

“LLSV” – Liquid Line Solenoid Valve: indicates the position of the LLSV (open or closed)

“Comp” – Compressor: indicates the status of the compressor (on or off)

“TempSet” – Tank Temperature Setpoint: indicates the desired tank temperature to be maintained

“CondFlow” – Condenser Flow: indicates if there is water flowing through the condenser

“Cond” – Condenser Temperature: indicates the leaving water temperature from the condenser

“SLT” – Suction Line Temperature: indicates the suction line temperature of the unit right before the compressor

“Evap1” – Evaporator 1: indicates the evaporator temperature of the first evaporator

“CTD” – Compressor Time Delay: indicates remaining time in compressor delay countdown

“PTD” – Pump Time Delay: indicates remaining time in pump countdown, when the count down starts the pump turns on

“Remote Mode Indicator” – indicates if this unit is connected to a master panel via Ethernet, if it isn't then it will display a start button if a tank temperature probe is installed

“Alarm Indicator” – indicates if there is a system alarm, click on the button to see which alarm is currently triggered

“Defrost Indicator” – indicates if the unit is in a defrost cycle (in a defrost cycle the compressor shuts off and lets the fans run to warm up the evaporator)

“Blower” - Status of the blower motor overload

“Tank” - Temperature read out of the tank the unit is heating

“SH” - Compressor Superheat

“ENV” - Indicates whether unit is in normal performance envelope, extended envelope, or out of envelope

ALARM SCREEN

“HIGH PRESSURE” – indicates if the unit has alarmed out on high pressure

“LOW PRESSURE” – indicates if the unit has alarmed out on low pressure **“SHORT CYCLE”** – indicates if the unit has been short cycling

“OUTLET FLOW” – indicates if the unit has alarmed out on condenser water flow

“Evap Flow” – indicates if the evaporator has flow.

“M PROTECTION” – indicates if the unit has alarmed out on motor protection

“Out of ENV” - Unit shutdown after being outside performance envelope for 2 minutes without being able to stage the VFD up or down at max or min speed.

CONFIGURATION SCREEN

“Temperature Diff” – Temperature Differential: sets the temperature difference below setpoint where the unit will turn on (only available if the unit isn't in remote mode)

“CondFlow” – Condenser Flow: indicates the flow-rate through the condenser (based on frequency read by PLC through integrated paddle wheel flow sensor)

“Low Limit” – Sets the lowest flow rate limit that the unit will shut off at (enabled for Single-Pass applications only), press the save button to save the lower limit in a Single-Pass configuration

“Compressor Hours” – Compressor Hours: indicates the run hours of the compressor

“Purge” button – this button will run the pump relay for 2 minutes to allow you to purge the system without turning on the units

“Tank/Pipe” - Unit call probe location, probe is recommended inside of tank whenever possible.

“Diff Timer” - Timer to control tank load matching with a VFD operated compressor.

“Max Tank Increase” - Allows you to specify the maximum tank increase using the “Diff Timer” in load matching

“Min Tank Increase” Allows you to specify the minimum tank increase using the “Diff Timer” in load matching

STOP SCREEN



The stop screen will pop up as a confirmation whenever the “STOP” button on any screen is pressed.

IP CONFIGURATION

New Nyle units can be configured for a variety of different networks on the fly and the procedure is quick and easy to accomplish.

1. Connect the Sim/Configuration Jumper to your Nyle Systems C250 Unit you would like to configure.

2. Navigate to the “Diag” button in the bottom right corner of your screen and select “IP Configuration”

Unit IP Address – This IP address is the designation for the unit itself, Nyle recommends running the system on factory settings (ex. 192.168.1.(“Unit Number” AKA 1))

Unit IP Subnet – This number is used to determine the size of the network the unit is connecting to. (ex. 255.255.255.0)

Master IP Address – This is the address of the Nyle Systems Master Panel (ex. 192.168.1.50)

Unit Number – Only used for custom network configurations, this configures your Nyle unit to connect to a Master Panel under a desired number.

MAINTENANCE AND SERVICE

ROUTINE MAINTENANCE

Warning: When possible, disconnect all power to the unit and follow the prescribed lock - out/tag - out procedure to prevent accidental electrocution. Should the unit have to be serviced with live electricity, only trained and qualified technicians should carry out the service. Failure to follow all of the safety warnings may result in serious injury or death.

The temperature-pressure relief valve must be manually operated at least once a year. Caution should be taken to ensure that (1) no one is in front of or around the outlet of the temperature pressure relief valve discharge line, and (2) the water manually discharged will not cause any bodily injury or property damage because the water may be extremely hot. If after manually operating the valve, it fails to completely reset and continues to release water, immediately close the cold water inlet to the heat pump, follow the draining instructions in the storage tank manual, and replace the temperature-pressure relief valve with a properly rated/sized new one.

If you do not understand these instructions or have any questions regarding the temperature-pressure relief valve call the toll free number listed on the back cover of this manual for technical assistance.

AIR FILTERS

Note: If return duct is connected to the unit, be sure to install a filter access door.

Initially, check filters on a monthly basis for dust buildup. Replace throw-away cotton media filters when necessary with new filters. Make sure the arrows on the filter are pointing in the direction of the air flow.

An aluminum mesh filter should be used for applications with significant grease or dust buildup. To clean, wash under a stream of hot water to remove the dirt and lint. To remove grease, apply a grease cutting soap and thoroughly rinse. Allow the filter to dry. Reinstall the filter.

DRAIN PAN

Warning: Read all of the warnings on the bottle of the cleaning products used for drain pan cleaning. Follow all instructions for personal protection and safe application of the products. Before cleaning the drain pan, disconnect all power to the unit and follow the prescribed lock-out/tag-out procedure.

The condensate pan and drain line must be checked for cleanliness, growth and blockage at least every six months.

To clean drain pan, start by disconnecting the power to the unit. Wear the appropriate personal protective equipment prescribed by the cleaning product instructions. Apply the cleaning solution and scour the sides of and bottom of the drain pan. Remove all large solid particles that could potentially clog up the drain line. If algae or mold are found growing in the pan, after cleaning, apply a mild bleach and water solution and brush on the growth areas. Rinse the drain pan thoroughly with water and dry for a final visual inspection.

BLOWER ASSEMBLY

Before performing any maintenance on the blower assembly, disconnect all power to the unit and follow the prescribed lockout/ tag-out procedure.

Inspect and tighten all bearing collar and wheel set screws after the first 50 to 200 hours of operation and there after, at least every six months. During inspection, visually check the drive belt for wear or cracking. Replace as necessary, but do not apply any belt dressing products.

Inspect all set screws on the pulleys, wheel and bearing lock collars. Check the belt for proper tension and alignment.

Clean the blower wheel periodically as material buildup on the blades can cause a wheel imbalance that may lead to wheel or bearing failure.

The pillow block bearings come pre-lubricated from the factory. These bearings should be lubricated at least once per year. The recommended lubricant is Shell Alvania #2 or S3. Caution: overfilling the bearing may rupture the seal and damage the bearing. Apply the grease slowly as the shaft is rotating. Motor grease is not compatible for bearings. Only use grease designated for bearing use.

BLOWER MOTOR

Warning: before performing any maintenance on the blower motor, disconnect all power to the unit and follow the prescribed lock-out/tag-out procedure.

Every six months visually inspect the blower motor. Clean off any dust, grease or oily buildup and vacuum out any cavities in the motor. It may be necessary to periodically disassemble the motor for a more thorough internal cleaning.

Motors are permanently lubricated from the factory. It is not necessary to lubricate the motor upon start-up or lubricate as part of maintenance.

EVAPORATOR COIL

WARNING: READ ALL OF THE WARNINGS PROVIDED FOR THE CLEANING PRODUCTS USED FOR REFRIGERATION COIL CLEANING. FOLLOW ALL INSTRUCTIONS FOR PERSONAL PROTECTION AND SAFE APPLICATION OF THE PRODUCTS. BEFORE CLEANING EVAPORATOR, DISCONNECT ALL POWER TO THE UNIT AND FOLLOW THE PRESCRIBED LOCK-OUT/TAG-OUT PROCEDURE.

Inspect the evaporator coil for dirt buildup or fin crush on at least once per year. If there are signs of fin fold over, use a fin comb to straighten the fins. Should the coils need cleaning, follow the steps listed below:

1. Disconnect all power to the unit and follow the prescribed lock-out/tag-out procedure.
2. Wear the prescribed personal protective equipment prescribed from the cleaning product instructions.
3. Install a block-off sheet to prevent splash over into the dry sections of the HPWH.
4. Prepare the cleaning solution as prescribed from the cleaning product instructions and fill the mixture into a high-pressure sprayer.
5. Start spraying both sides of the coil keeping the nozzle perpendicular to the coil at least 6 inches from the coil face. Do not exceed 600 psi.
6. Thoroughly rinse the cleaned coil with cool, clean water.
7. Straighten out any fins displaced during the cleaning using a fin comb.
8. Confirm the drain pan line is not clogged.
9. Replace all panels on the unit and wipe down any standing cleaning solution or water on or around the unit.

CLEANING INTERNAL INSULATION

Inspect the internal insulation on a yearly basis for any microbial growth. The insulation never has to be cleaned unless microbial growth is detected. If microbial growth is detected, follow the removal steps below:

1. Disconnect all power to the unit and follow the prescribed lock-out/tag-out procedure.
2. Wear the prescribed personal protective equipment prescribed from the cleaning product instructions.
3. Remove as much dirt and organic material from the insulation using a vacuum device with a HEPA filter (99.97% efficient at 0.3 micron particles). Be careful not to tear the insulation during the cleaning procedure.
4. Apply the microbial cleaning agent as prescribed by the application and usage instructions.
5. Allow the unit to dry thoroughly.
6. If necessary, apply an anti-microbial agent on the insulation per the instructions provided on the product label.

Discard collected microbial contaminants as required by local or state codes.

CHECKING REFRIGERANT CHARGE

Servicing of the refrigeration circuit must only be performed by agencies or individuals possessing Type II or Universal certification as defined in Section 608 of the Clean Air Act. See Qualifications on page 3.

This HPWH unit is factory charged with 134a refrigerant. See the rating label on the HPWH unit and Table 9 on page 32 for refrigerant charge by weight. It should not be necessary to add or remove refrigerant during installation or start up. Refrigerant lost during frequent refrigerant pressure testing can cause low refrigerant conditions. Air and water flow should always be checked first to eliminate other potential problems before checking the refrigerant charge.

CHECK AIR FLOW

If so equipped, ensure the air filters are clean. Ensure the evaporator coil is clean. Ensure the blower motor belt is not worn or loose. See Figure 1 on page 7 for component locations. Correct any problems with air flow before checking the refrigerant pressures.

CHECK WATER TEMPERATURE RISE

Always check water temperature rise through the HPWH unit's internal heat exchanger before checking the refrigerant charge. See Start Up on page 22 for information on how to measure the water temperature rise.

If the measured water temperature rise during start up was within 8°F to 12°F (4°C to 7°C) checking the charge is not necessary unless other conditions warrant testing.

If the measured temperature rise through the HPWH unit is less than 8°F (4°C) checking the charge is not necessary unless other conditions warrant testing. Short water piping runs between the HPWH and the storage tank will produce lower temperature rises and are not problematic.

If the measured temperature rise through the HPWH unit is more than 12°F (7°C) check for restrictions in the inlet and outlet water piping connected between the HPWH unit and the storage tank.

TABLE 9

<i>Model</i>	<i>Factory Charge R134A</i>
C25A	7 #
C60A	14 #
C90A	21 #
C125A	25 #
C185A	30 #
C250A	42 #

SUPERHEAT CALCULATION

1. Measure and record the suction pressure at the suction line pressure access port inside the unit.
2. Convert the recorded suction pressure to saturated temperature.
3. Measure the suction line temperature near the suction line pressure access port inside the unit.
4. Compare the suction line temperature to the saturated temperature in Table 10.
5. The difference between saturated temperature and suction line temperature is the superheat. Superheat normal range should be 8°F to 12°F (4.4°C to 6.7°C)

BRAZE PLATE CLEANING INSTRUCTIONS

In some applications the heat exchanger may be subjected to severe fluid conditions, including high temperature hard water conditions, causing accelerated scaling and corrosion rates, and will diminish performance.

It is important to establish regular cleaning schedules, A 5% solution of Phosphoric Acid or Oxalic Acid may be considered. Other types of solutions can be obtained from your local wholesaler. Make sure cleaning solution is applicable for stainless steel and copper and all directions are followed.

Do not heat solution. Be sure to flush heat exchanger with fresh water after cleaning. See Figure 12.

TABLE 10

R134A SATURATED TEMPERATURE CHART		
SATURATED TEMPERATURE °F	SATURATED TEMPERATURE °C	REFRIGERANT PRESSURE (PSI)
0	-18	7
5	-15	9
10	-12	12
15	-9	15
20	-7	18
25	-4	22
30	-1	26
35	2	30
40	4	35
45	7	40
50	10	45
55	13	51
60	16	57
65	18	64
70	21	71
75	24	79
80	27	87
85	29	95
90	32	104
95	35	114
100	38	124
105	41	135
110	43	146
115	46	158
120	49	171
125	52	185
130	54	199
135	57	214
140	60	229
145	63	246
150	66	263
155	68	281

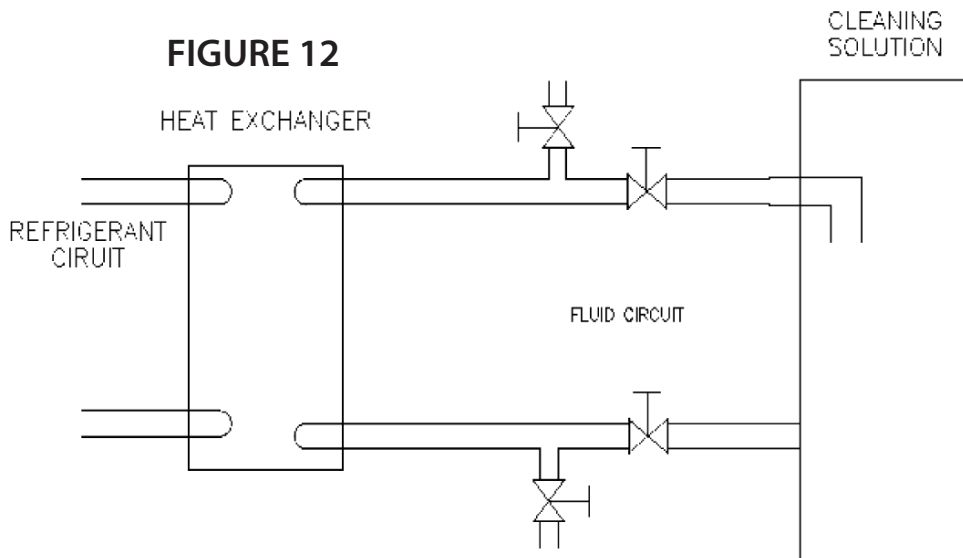

TROUBLESHOOTING

<i>Problem</i>	<i>Possible Causes</i>	<i>Corrections</i>
Heat Pump is too noisy	<ol style="list-style-type: none"> 1. Sheet Metal fasteners are loose. 2. Operating vibration is transferring to floor or building structure. 3. Blower pulley assembly loose or out of alignment 	<p>Tighten Fasteners</p> <p>Place vibration dampers underneath unit</p> <p>Tighten or align pulleys</p>
Water on floor around the heat pump and or water tank	<ol style="list-style-type: none"> 1. Tubing, valves, or fittings are leaking 2. Heat Pump is not leveled causing drain pan overflow 3. Condensate trap not installed properly 4. Drain pan overflowing 5. Condensation forming on the bottom of unit (humid environments) 	<p>Repair leaks as necessary</p> <p>Shim unit to level, See installation section</p> <p>Condensate trap depth must maintain a water column during operation</p> <p>Use pipe snake or compressed air to remove obstruction</p> <p>Cover bottom of unit with foam insulation</p>
Heat Pump is not running - Electrical issues	<ol style="list-style-type: none"> 1. Circuit does not have adequate ampacity 2. Short circuit or loose connection in field wiring 3. Short circuit or loose connection in the cabinet 4. Thermostat Failure 5. Defective anti-short cycle timer 6. Compressor burn-out 	<p>Refer to nameplate for unit requirements</p> <p>Check field wiring diagram, Tighten all connections</p> <p>Check for loose wiring and tighten</p> <p>Replace thermostat</p> <p>Reset phase monitor</p> <p>Replace Compressor (refer to compressor change-out page)</p>
Heat Pump is not running - High Pressure Fault	<ol style="list-style-type: none"> 1. Thermostat setting too high 2. Air temperature over 95° F 3. Low water flow causes <ol style="list-style-type: none"> a. External Pump is not operating b. Piping between the heat pump and storage tank exceeds 50 equivalent feet c. Heat exchanger has scale buildup d. Shut off valves are partially closed 	<p>Thermostat setting should not exceed 160° F</p> <p>Keep heat pump off until room temperature is back in operating range</p> <p>Low water flow corrections</p> <p>Replace unit pump</p> <p>Reduce piping or add booster pump</p> <p>Clean heat exchanger with a mild acid wash</p> <p>Open all shut off valves</p>
Heat Pump is not running - Low Pressure Fault	<ol style="list-style-type: none"> 1. Room temperature below 40° F 2. Blower not operating at nameplate CFM - blower belt is broken or out of alignment filters are dirty 3. Unit does not have adequate clearances obstructing air flow 4. Loss of Refrigerant 	<p>Keep heat pump off until room temperature is back in operating range</p> <p>Correct air-flow issue</p> <ol style="list-style-type: none"> i. Replace or realign pulley assembly; tighten belt at the adjustable pulley ii. Replace filters iii. Relocate unit to allow for even air flow <p>Find source of leak, repair, and recharge</p>
Water is never hot enough	<ol style="list-style-type: none"> 1. Thermostat setting is too low 2. Heat pump/storage tank undersized for application 3. Heat pump is not properly connected to storage tank. 4. Unit cooling coil is over cooling the space 	<p>Set thermostat for storage tank to a higher temperature</p> <p>Increase size of storage tank or install gas or electric heater to make up for shortfall</p> <p>Refer to field piping diagrams for recommended piping</p> <p>If the room air temperature is too cool a) Use back up water heating b) Duct cool air to another space c) duct warmer air from another space to the installed room</p>
Cooling coil is icing	<ol style="list-style-type: none"> 1. Insufficient air flow through the unit 2. Low air temperature 3. Partial refrigerant loss 4. Defective TX valve 5. Clogged filter dryer 	<p>Refer to "Heat pump not running - low pressure fault" section for correction suggestions</p> <p>If room air temperature is too cool a) Use back up water heating b) Duct cool air to another space c) Duct warmer air from another space to installed room</p> <p>Find source of leak</p> <p>Replace TX valve</p> <p>Replace filter dryer</p>

*Reset the heat pump by removing then restoring power to the unit at the breaker or from the manual switch. (There will be a three minute delay before heat pump restarts.) If the heat pump cuts out again on LOW or HIGH PRESSURE, additional troubleshooting is necessary to find the cause.

DO NOT CONTINUE TO RESET THE HEAT PUMP, AS CONTINUED SHORT-CYCLING MAY STRESS OR DAMAGE INTERNAL COMPONENTS

SINGLE-PASS

ONE AIR TO WATER HEAT PUMPS, SINGLE TEMPERATURE WITH TWO VERTICAL STORAGE TANKS AND ONE SWING TANK WITH RESISTIVE BACKUP / REHEAT

WARNING: THIS DRAWING SHOWS SUGGESTED PIPING CONFIGURATION AND OTHER DEVICES; CHECK WITH LOCAL CODES AND ORDINANCES FOR ADDITIONAL REQUIREMENTS.

LEGEND

	MIXING VALVE		TEMPERATURE & PRESSURE RELIEF VALVE
	BALL VALVE AND HOSE BIBB		PRESSURE RELIEF VALVE
	ELECTRICAL WIRES		CIRCULATING PUMP
	PIPING		TANK OR LINE TEMPERATURE CONTROL
			WYE STRAINER
			FULL PORT BALL VALVE
			CHECK VALVE
			TEMPERATURE GAGE
			DRAIN
			BALANCING VALVE

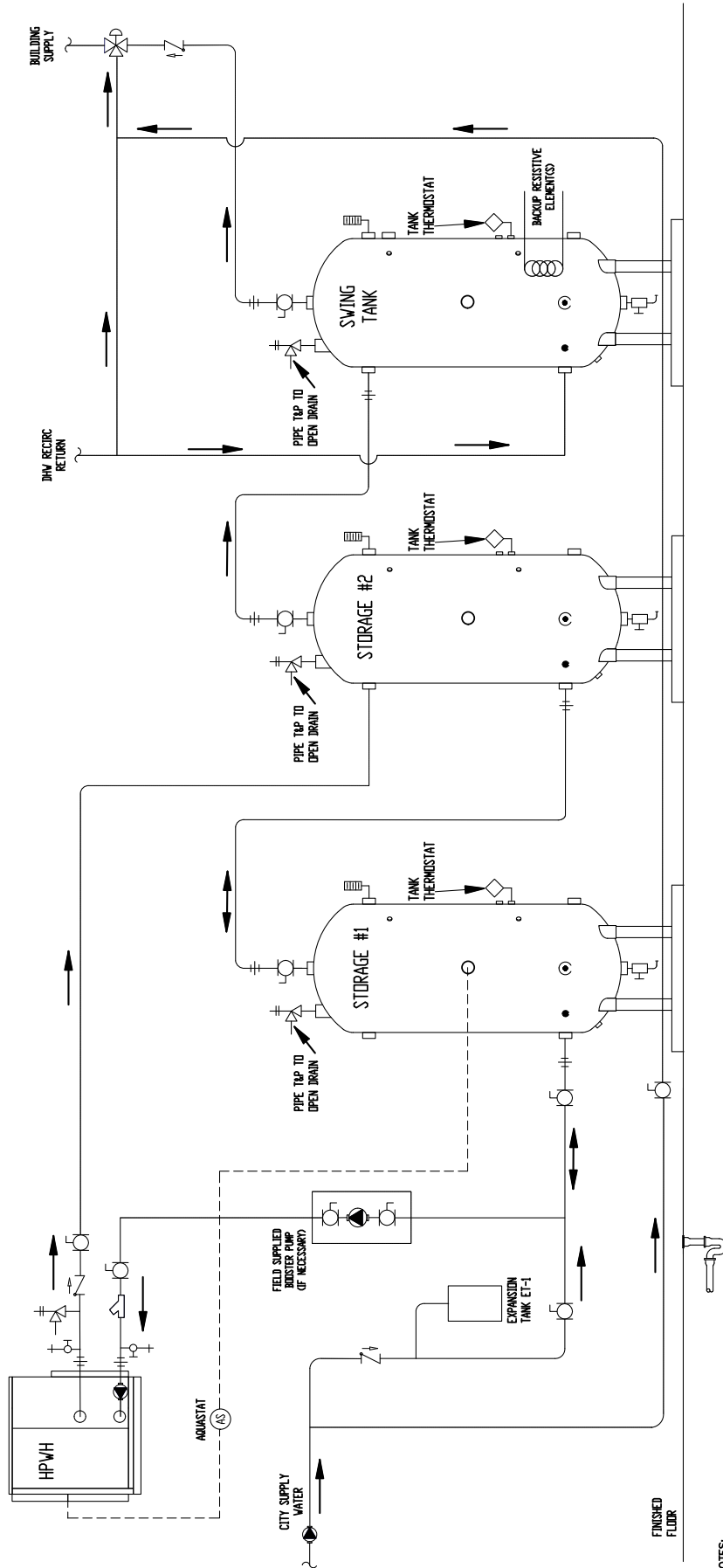

- NOTES:
1. PREFERRED PIPING DIAGRAM.
 2. THE TEMPERATURE AND PRESSURE RELIEF VALVE SETTING SHALL NOT EXCEED PRESSURE RATING OF ANY COMPONENT IN THE SYSTEM.
 3. SERVICE VALVES ARE SHOWN FOR SERVICING UNIT. HOWEVER, LOCAL CODES SHALL GOVERN THEIR USAGE.

SINGLE-PASS

TWO AIR TO WATER HEAT PUMP, SINGLE TEMPERATURE
WITH ONE VERTICAL STORAGE TANK AND ONE SWING TANK

WARNING: THIS DRAWING SHOWS SUGGESTED
PIPING CONFIGURATION AND OTHER DEVICES;
CHECK WITH LOCAL CODES AND ORDINANCES
FOR ADDITIONAL REQUIREMENTS.

LEGEND

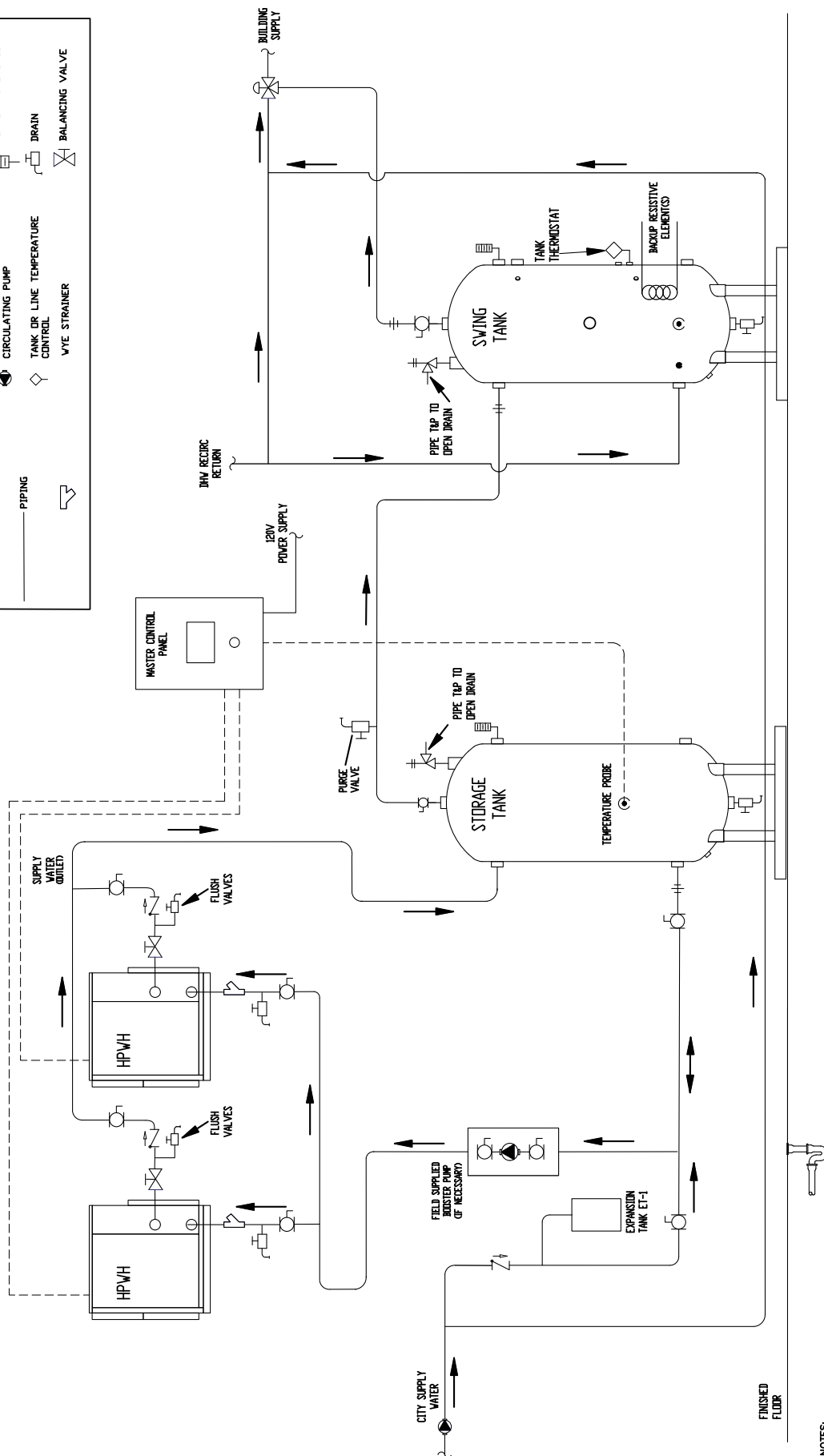
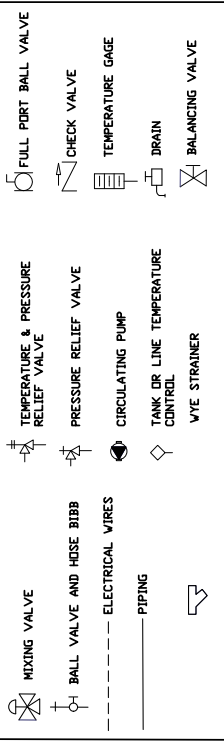

- NOTES:
1. PREFERRED PIPING DIAGRAM.
 2. THE TEMPERATURE AND PRESSURE RELIEF VALVE SETTING SHALL NOT EXCEED PRESSURE RATING OF ANY COMPONENT IN THE SYSTEM.
 3. SERVICE VALVES ARE SHOWN FOR SERVICING UNIT. HOWEVER, LOCAL CODES SHALL GOVERN THEIR USAGE.

SINGLE-PASS TWO AIR TO WATER HEAT PUMP, SINGLE TEMPERATURE WITH ONE VERTICAL STORAGE TANK

WARNING: THIS DRAWING SHOWS SUGGESTED PIPING CONFIGURATION AND OTHER DEVICES; CHECK WITH LOCAL CODES AND ORDINANCES FOR ADDITIONAL REQUIREMENTS.

LEGEND

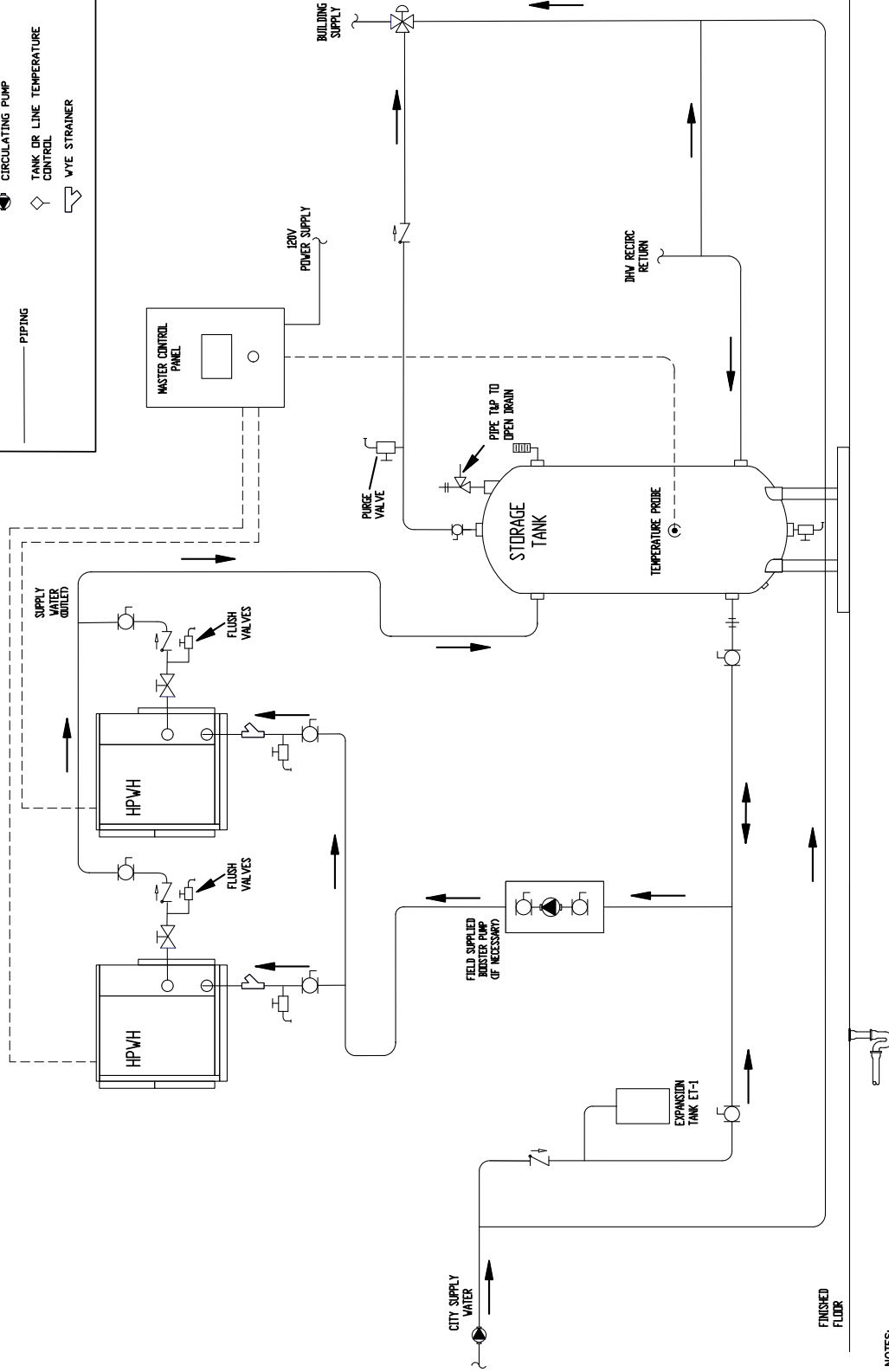
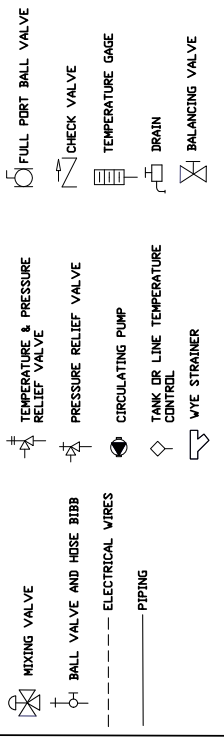

- NOTES:
1. PREFERRED PIPING DIAGRAM.
 2. THE TEMPERATURE AND PRESSURE RELIEF VALVE SETTING SHALL NOT EXCEED PRESSURE RATING OF ANY COMPONENT IN THE SYSTEM.
 3. SERVICE VALVES ARE SHOWN FOR SERVICING UNIT. HOWEVER, LOCAL CODES SHALL GOVERN THEIR USAGE.

ONE AIR TO WATER HEAT PUMP, SINGLE TEMPERATURE PROBE WITH ONE VERTICAL STORAGE TANK WITH FORCED BUILDING RECIRCULATION

WARNING: THIS DRAWING SHOWS SUGGESTED PIPING CONFIGURATION AND OTHER DEVICES; CHECK WITH LOCAL CODES AND ORDINANCES FOR ADDITIONAL REQUIREMENTS.

LEGEND

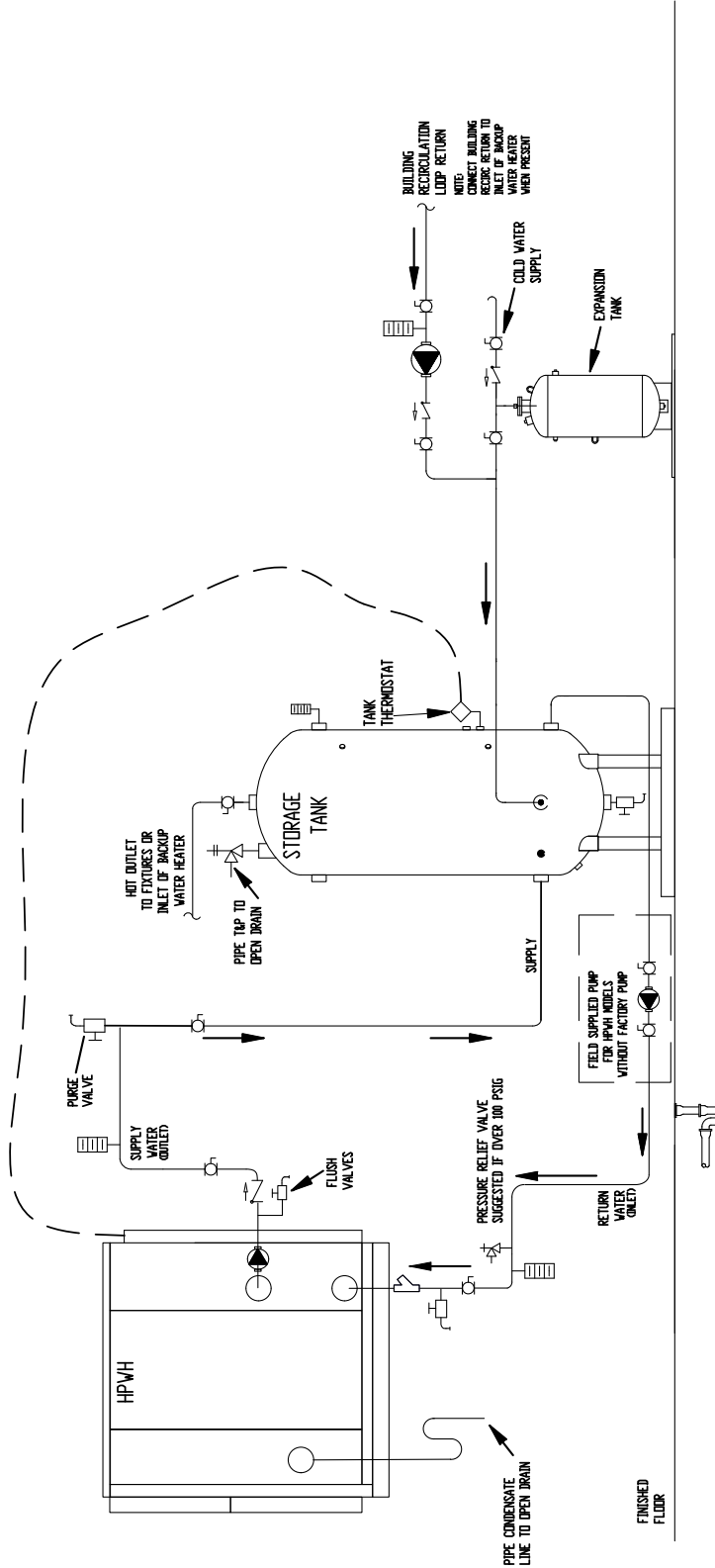
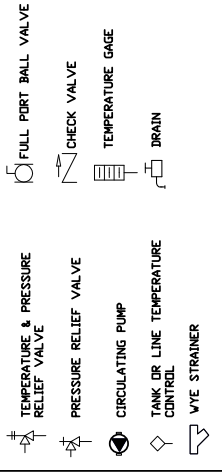

- NOTES:
1. PREFERRED PIPING DIAGRAM.
 2. THE TEMPERATURE AND PRESSURE RELIEF VALVE SETTING SHALL NOT EXCEED PRESSURE RATING OF ANY COMPONENT IN THE SYSTEM.
 3. SERVICE VALVES ARE SHOWN FOR SERVICING UNIT. HOWEVER, LOCAL CODES SHALL GOVERN THEIR USAGE.

WARNING: THIS DRAWING SHOWS SUGGESTED PIPING CONFIGURATION AND OTHER DEVICES; CHECK WITH LOCAL CODES AND ORDINANCES FOR ADDITIONAL REQUIREMENTS.

WARNING: THIS DRAWING SHOWS SUGGESTED PIPING CONFIGURATION AND OTHER DEVICES. CHECK WITH LOCAL CODES AND ORDINANCES FOR ADDITIONAL REQUIREMENTS.

MULTI-PASS THREE AIR TO WATER HEAT PUMPS, SINGLE MAINTAINED TEMPERATURE TWO VERTICAL STORAGE TANKS RESISTIVE BACKUP

LEGEND

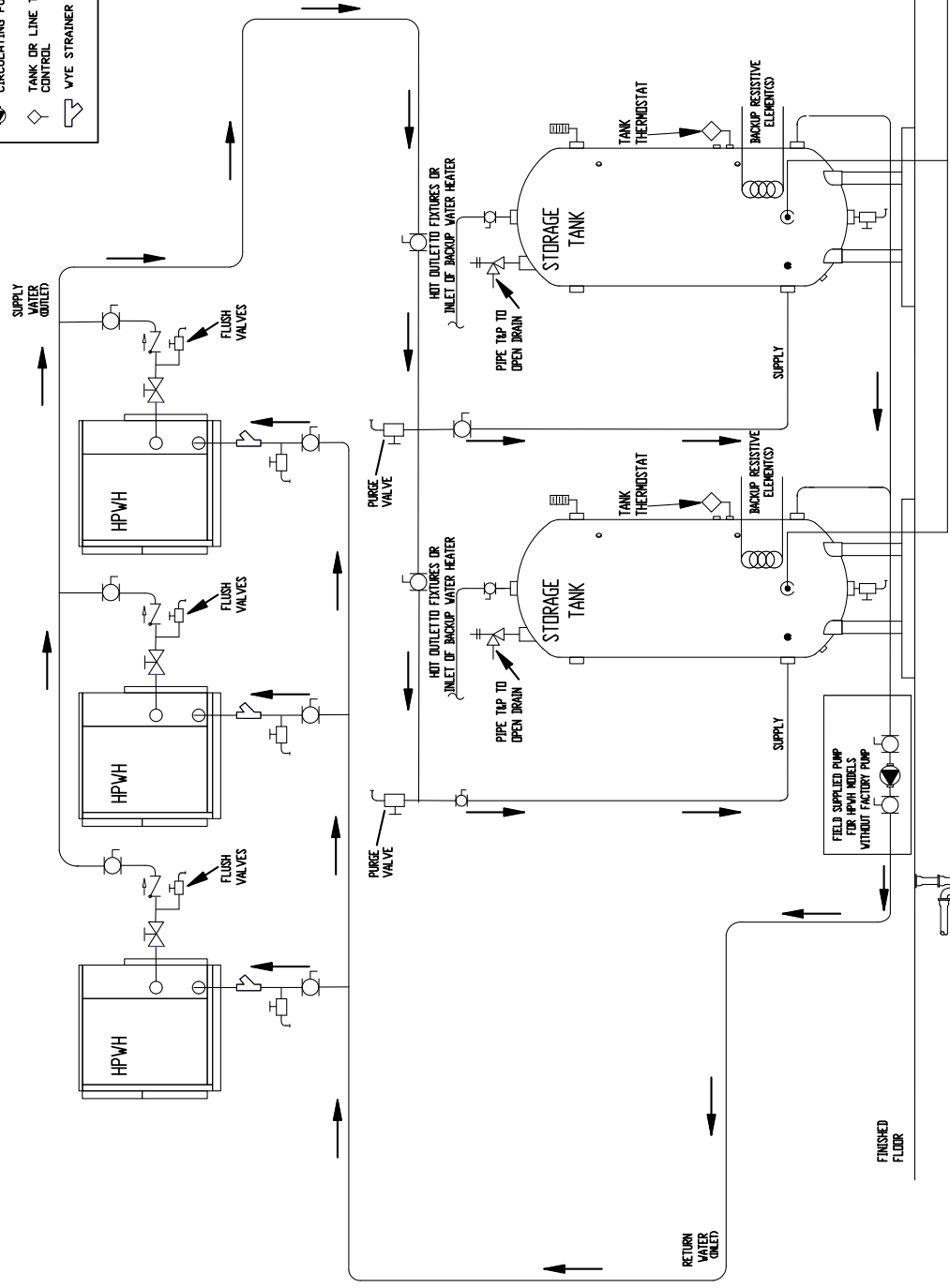
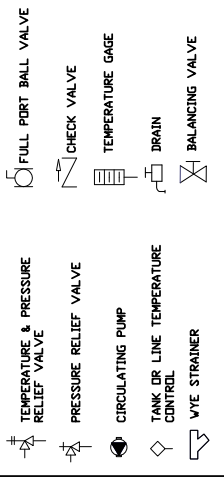

- NOTES:
1. PREFERRED PIPING DIAGRAM.
 2. THE TEMPERATURE AND PRESSURE RELIEF VALVE SETTING SHALL NOT EXCEED PRESSURE RATING OF ANY COMPONENT IN THE SYSTEM.
 3. SERVICE VALVES ARE SHOWN FOR SERVICING UNIT. HOWEVER, LOCAL CODES SHALL GOVERN THEIR USAGE.

CV MAKEUP

LIMITED WARRANTY

Nyle Water Heating Systems, the warrantor, extends the following LIMITED WARRANTY to the original owner of this commercial heat pump water heater subject to the terms, conditions and disclaimers stated below:

1. COMPRESSOR

If the 5-Year Extended Compressor Warranty is purchased, and if within FIVE (5) years after delivery of this heat pump water heater the compressor shall prove, upon examination by the warrantor, to be defective, the warrantor will provide a replacement compressor.

2. ALL OTHER PARTS

If within 18 months after delivery or 12 months after commissioning[†] of this heat pump water heater any other part or portion shall prove, upon examination by the warrantor, to be defective in material or workmanship, the warrantor will repair or replace such part or portion at its option. This warranty also extends to any factory supplied accessories.

3. CONDITIONS AND EXCEPTIONS

Refrigerant, filters, refrigerant driers, and fan belts are not covered under this limited warranty. The warranty on all replacement parts, including the compressor, will be limited to the unexpired term of the original warranty. This warranty shall apply only when the heat pump water heater is installed in accordance with local plumbing and building codes, ordinances and regulations, the warrantor's printed instructions provided with it and good industry practices.

a. This warranty shall apply only when the unit is:

- (1) used at temperatures not exceeding the maximum system temperatures printed in the instructions provided;
- (2) filled with potable water, free to circulate at all times and free of damaging water sediment or scale deposits;
- (3) used in a non-corrosive and not contaminated atmosphere;
- (4) in its original installation location, and under original ownership;
- (5) in the United States, its territories or possessions, Canada, South America, Caribbean and Mexico;
- (6) sized in accordance with proper sizing techniques for commercial heat pump water heaters;
- (7) bearing the original rating label which has not been altered, defaced or removed, except as required by the warrantor;
- (8) energized at the proper voltage and phase as stated on the rating label;
- (9) maintained in accordance with the instructions printed in the manual included with the heat pump water heater;

b. Any accident to the water heater, any misuse, abuse (including freezing) or alteration of it, any operation of it in a modified form, will void this warranty.

4. SERVICE REPAIR AND EXPENSE

Under this limited warranty the warrantor will provide only a replacement heat pump water heater or part thereof. The owner is responsible for all other costs. Such costs may include but are not limited to:

- a. Labor charges for service, removal, repair, or re installation of the water heater or any component part;
- b. Shipping, delivery, handling, and administrative charges for forwarding the new heater or replacement part from the nearest distributor and returning the claimed defective heater or part to such distributor;
- c. All cost necessary or incidental for any materials and/or permits required for installation of the replacement heater or part.

5. LIMITATIONS ON IMPLIED WARRANTIES

Implied warranties, including any warranty of merchantability imposed on the sale of this heater under state law are limited to 18 months after delivery or 12 months after commissioning[†] duration for the heater or any of its parts. Some states do not allow limitations on how long an implied warranty lasts, so the above limitation may not apply to you.

6. CLAIM PROCEDURE

Any claim under this warranty should be initiated with the dealer who sold the heater, or with any other dealer handling the warrantor's products. If this is not practicable, the owner should contact:

Nyle Water Heating Systems, LLC
12 Stevens Road
Brewer, Maine 04412
(800) 777-6953

a. The warrantor will only honor replacement with identical or similar water heater or parts thereof which are manufactured or distributed by the warrantor.

b. Dealer replacements are made subject to in-warranty validation and approval by warrantor.

7. DISCLAIMERS

NO OTHER EXPRESS WARRANTY HAS BEEN OR WILL BE MADE IN BEHALF OF THE WARRANTOR WITH RESPECT TO THE MERCHANTABILITY OF THE HEATER OR THE INSTALLATION, OPERATION, REPAIR, OR REPLACEMENT OF THE HEATER. THE WARRANTOR SHALL NOT BE RESPONSIBLE FOR WATER DAMAGE, LOSS OF USE OF THE UNIT, INCONVENIENCE, LOSS OR DAMAGE TO PERSONAL PROPERTY, OR OTHER CONSEQUENTIAL DAMAGE. THE WARRANTOR SHALL NOT BE LIABLE BY VIRTUE OF THIS WARRANTY OR OTHERWISE FOR DAMAGE TO ANY PERSONS OR PROPERTY, WHETHER DIRECT OR INDIRECT, AND WHETHER ARISING IN CONTRACT OR IN TORT.

a. Some states do not allow the exclusion or limitation of the incidental or consequential damage, so the above limitation or exclusion may not apply to you.

b. This warranty gives you specific legal rights, and you may also have other rights which vary from state to state.

c. This warranty is only valid if the following are completed and returned to Nyle Water Heating Systems, LLC within 10 days of units' start up.

- Unit Warranty Registration Form
- Start Up Checklist

*All Unit Warranty Forms as well as our Online warranty registration can be found on our website

† Unit Warranty is to be 18mo from date of shipment or 12 mo. from commissioning if the commissioning report is sent in. The warranty is a maximum of 18 months.



Nyle Water Heating Systems, LLC
12 Stevens Road
Brewer, Maine 04412

(800) 777-6953
Sales: Ext 216
Service: Ext 208

nyle
**water heating
systems**